

BX1990 2006 Mercedes Smart for two CDI Installation Instructions

Serial Number

Please read BOTH these Installation Instructions and the General Instructions before attempting to install or operate this equipment.

- Blue Ox® towing products and accessories are intended to be installed by Blue Ox® Dealers who are familiar with our products and have the equipment necessary and knowledge to do “fit work”. When necessary Blue Ox® Dealers can be found at www.blueox.com or by contacting our Customer Care Department at (402) 385-3051.
- Many Blue Ox® Baseplates are designed to use existing holes and hardware to mount the baseplate to the towed vehicle. Even though bolts are there, do not assume they are adequate for baseplate mounting. Always use hardware supplied in the hardware kit and existing hardware specified in the Baseplate Installation Instructions.

Attachment Tab Height: 12.5”
Attachment Tab Width: 26 3/4”

Bolt Torque Specifications
Torque in Foot-Pounds for Metric Bolts

Bolt Size	Grade 8.8	Grade 10.9
6MM	6	8
8MM	16	22
10MM	31	40
12MM	54	70
14MM	89	117

Confirm the towability and pre-towing procedures for your vehicle with the owner’s manual or contact the vehicle’s manufacturer for specific towing procedures.

Bolt Torque Specifications
Torque in Foot-Pounds for Inch Bolts

Bolt Size	Grade 5	Grade 8
1/4”	10	14
5/16”	19	29
3/8”	33	47
7/16”	54	78
1/2”	78	119
5/8”	154	230



! WARNING

Failure to read and follow these instructions could result in separation of the towed vehicle from the tow bar, causing property damage, loss of towed vehicle, personal injury or death.

BX1990

2006 Mercedes Smart for two CDI

Installation Instructions

Parts List

Ref. No.	Qty.	Part #	Description
1	1	61-6747	WLDM'T, BP, BX1990
2	4	61-5208	3/8" NUT PLATE W/ 14" WIRE
3	4	201-0440	3/8-16 X 1 1/2 HEX BOLT, GRD.5, ZP
4	2	201-0368	3/8-16 X 1 1/4 HEX HEAD BOLT,GRD. 5
5	6	203-0010	3/8 LOCK WASHER, ZP
6	2	202-0090	3/8-16 HEX NYL. INS. LOCK NUT, ZP
7	2	201-0979	#12-14 x 1" SELF DRILLING SCREW, ZP
8	2	201-0192	10-32 X 1/2 SLOT, RD. HD. SCREW
9	2	203-0054	#10 LOCK WASHER
10	2	202-0047	#10-32 HEX NUT
11	2	101-5822	ADAPTER, 4 WAY CONNECTOR
12	2	62-3468	ATT TAB ASSY, REM, SF/SB, 1 HOLE
	2	226-0046	BASEPLATE SAFETY CABLE, 36" CL III (NS)
	4	229-0359	QUICKLINK, 3/8, ZP (Not Shown)
	2	290-0437	RECEIVER, CAP PLUG (BLK) (Not Shown)

Tools Required

8MM Socket	Large Vise Grip
15MM Socket	Reciprocating Saw
9/16" Socket/Wrench	Drill
T20 Torx	Flat Screwdriver
T25 Torx	Utility Knife
T30 Torx	Tape Measure
T40 Torx	13/32" Drill Bit
LOCTITE Red	

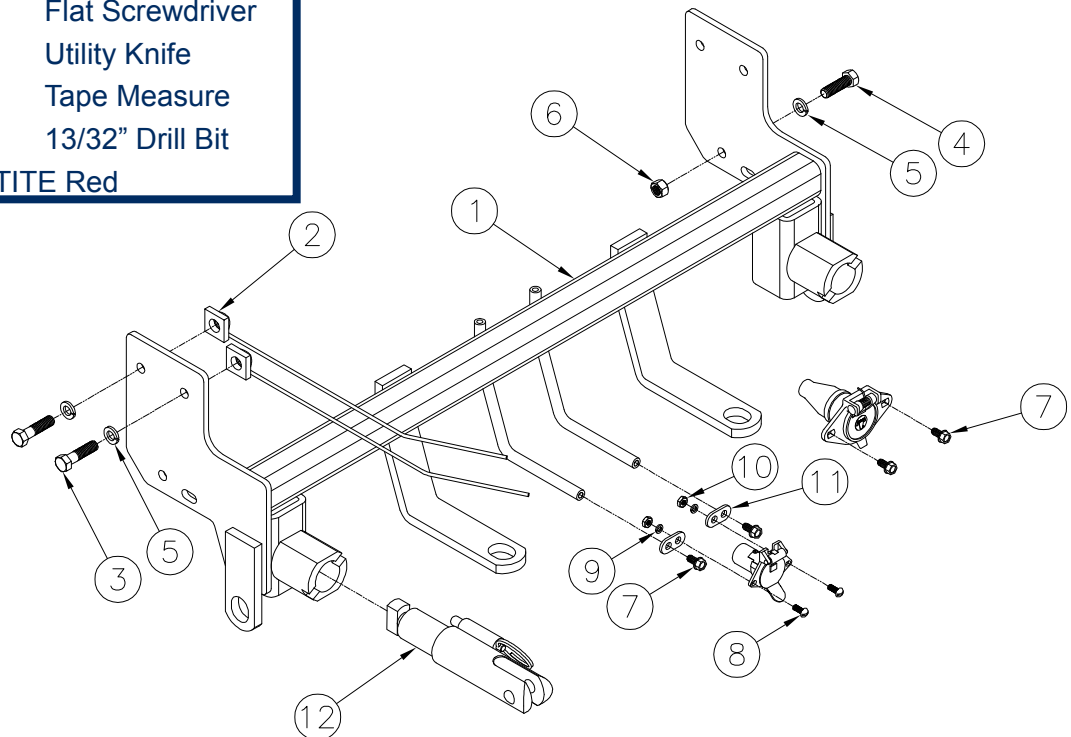

Important:

Use only genuine factory replacement parts on your baseplate. Do NOT substitute homemade or non-typical parts. If a bolt is lost or in need of replacement, for your safety and the preservation of your baseplate, be sure to use a replacement bolt of the same grade (In most cases it will be Grade 5, please reference the parts list above). Replacement parts may be ordered through your nearest Blue Ox® Dealer or Distributor, or call our Customer Care Team at (402)385-3051. Failing to follow and/or altering these installation instructions in either installation or required equipment will void the manufacturer's warranty. Towing behind a non-motorized vehicle will void the warranty.

BX1990

2006 Mercedes Smart for two CDI

Installation Instructions

Removable Tab:

Due to the design of the removable tabs, the RangeFinder II and Ambassador tow bars can not be used. Adapters, except the BX8833 and the BX88151, can not be used with this baseplate.

Instructions:

The antenna, grille, fascia, headlights, bumper, tires, bolts and push pins are removed and reinstalled for the baseplate installation. Drilling is required. Trimming of the bumper and the air dam is required.

The dimensional variations between otherwise identical vehicles can be considerable. While the baseplate was designed for easy installation, it may be necessary to tailor the baseplate slightly to compensate for auto manufacturer's tolerances. These minor adjustments may include filing a hole slightly, bending electrical rods or bending end plates.

The BX8848, 4 Diode wiring kit is recommended for this vehicle.

Handling of some cosmetic parts when installing this product may require the use of protective covers, rags, specialty tools, etc. to prevent damage.

Due to the narrow wheel base of the Smart Car there is a problem with the steering coming back to a straight position after making a turn. Bungee cords can be used to straighten the wheel back out. Place two bungee cords crossing from one side of the steering wheel to the other side of the driver seat, this gives resistance in each direction to bring the steering wheel back to center after making a turn.

Installation Instructions



1. Open the door and remove the bolt next to the antenna with the T30 Torx. Do this on both sides. Set the bolt aside to be reinstalled later.



2. Further down the door jam, with a T25 Torx remove four more bolts. Do this on both sides. Set the bolts aside to be reinstalled later.

BX1990

2006 Mercedes Smart for two CDI

Installation Instructions



3. In order to be able to remove the fascia, you must first unscrew the antenna. Lift off the corner of fascia next to the antenna to reveal a bolt. Using a T20 Torx, remove the bolt (3B). Do this on both sides of the vehicle. Set aside to be reinstalled later.



4. Using a flat screwdriver, push on the tabs in order to release and remove the grille. Push down on the three tabs on the top and push up on the four tabs on the bottom (4B). Set the grille aside to be reinstalled later.

BX1990

2006 Mercedes Smart for two CDI

Installation Instructions



5. Using the T25 Torx, remove the bolt to the inside of the headlight. Do this to both sides of the vehicle. Set the bolts and fascia aside carefully to be reinstalled later.

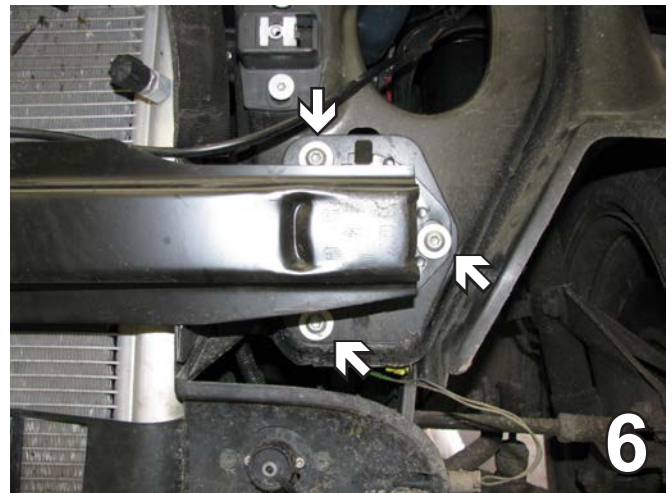

6. Using a T40 Torx, remove the three bolts from the bumper. Do this on both sides. Set aside to be reinstalled later.

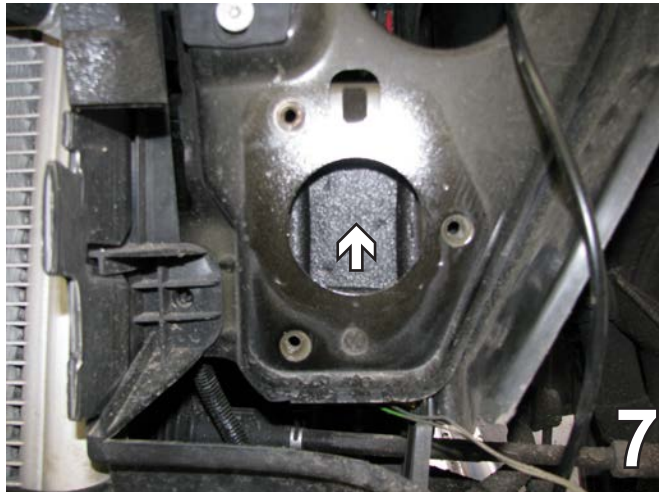

7. Remove the styrofoam piece that sets inside the hole in the frame. Do this on both sides. Set the styrofoam aside to be reinstalled later.



8. Using a 15MM socket, remove the three tire lug nuts. Remove the tire. Do this on all the tires. Set the nuts and tires aside to be reinstalled later.

BX1990

2006 Mercedes Smart for two CDI

Installation Instructions

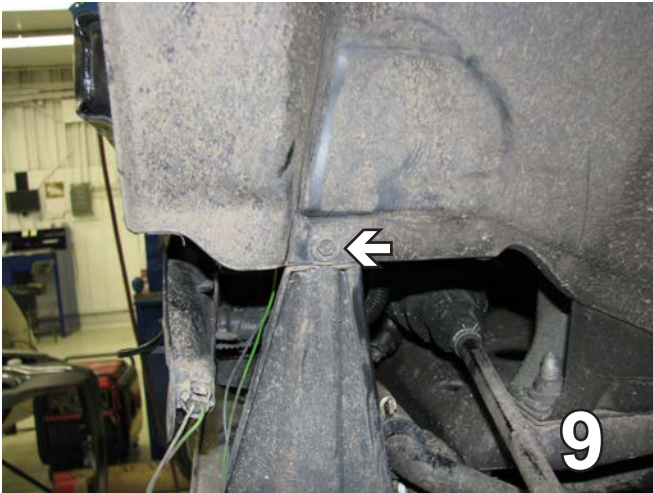

9. Using an 8MM socket, remove the bolt from the frame bracket. Do this on both sides. Set bolts aside to be reinstalled later.

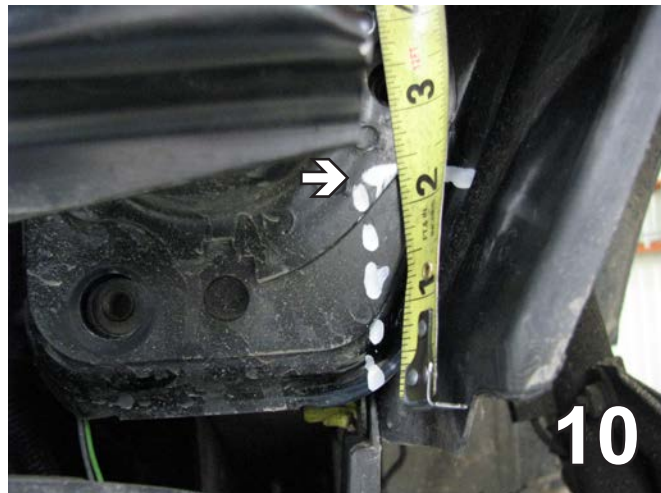

10. Using a reciprocating saw, cut flush with the outside edge of the frame 2 1/2" up and straight across directly underneath the nut. Do this on both sides.



11. Place a small, 2" x 4", block of wood behind the area before cutting to protect the plastic. Do this on both sides.

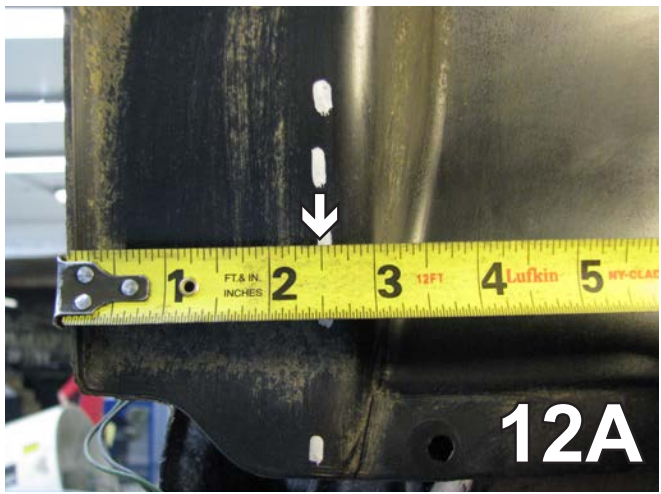

12A. Measure in 2 1/2" from the edge on the plastic guard.

BX1990 2006 Mercedes Smart for two CDI Installation Instructions

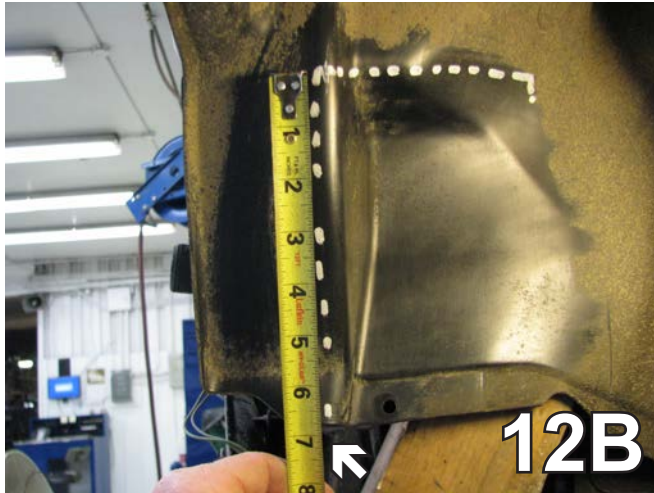

12B. Measure 7" up from the bottom and cut with a utility knife.

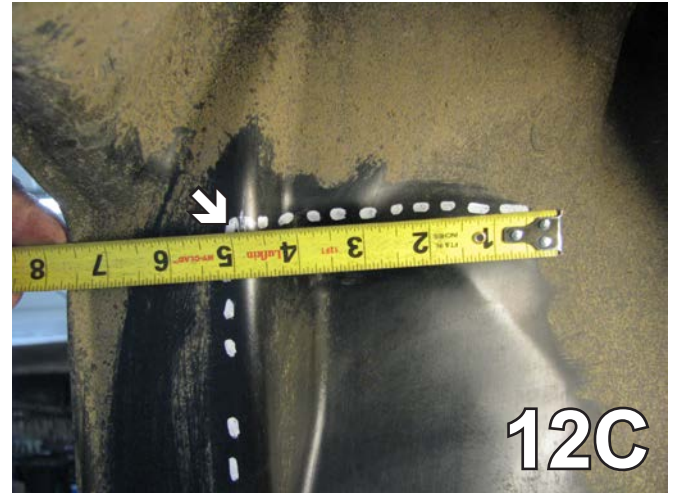

12C. Measure 5" across and cut with a utility knife. Fold the plastic back in order to insert the baseplate and drill the holes. Do this on both sides.

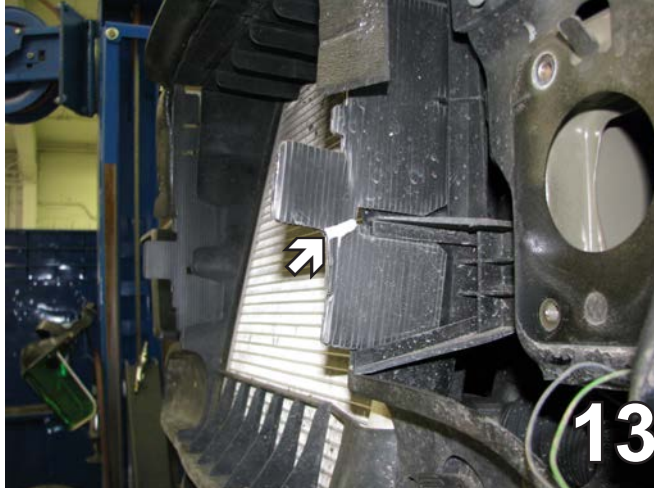

13. Using a utility knife, trim the tab as shown. Do this on both sides.

When using power drills be aware of the dangers of torque and drill bit length.



14. On the driver's side, disconnect the temperature sensor. It will need to be relocated. Cut straight down along the edge of the plug plate. On the passenger side, measure 3" over from the end of the frame and cut straight down.

BX1990

2006 Mercedes Smart for two CDI

Installation Instructions

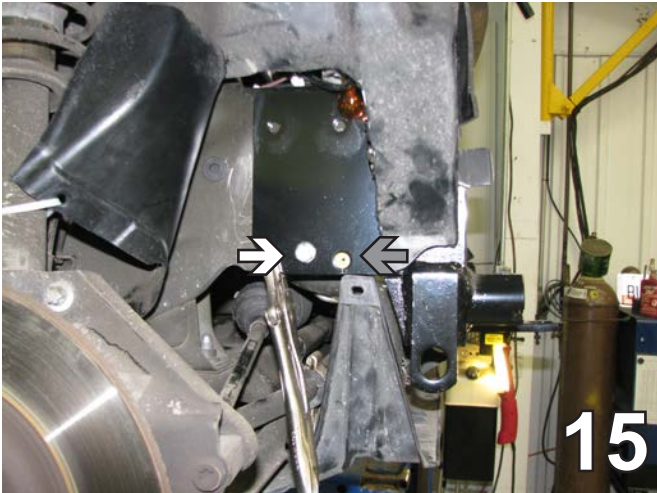

15. Align the baseplate with the existing hole (gray arrow) and clamp. Using the baseplate as a template with a 13/32" drill bit, drill the three holes. Insert into the bottom hole a 3/8-16 x 1 1/4" bolt with 3/8" lock washer, attach to a 3/8-16 nut on the inside. Use Loctite on all bolts. Do this on both sides.

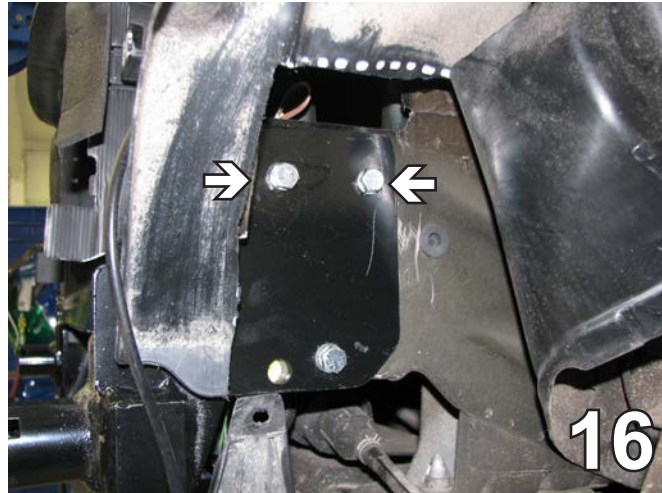

16. In the top two holes, use 3/8-16 x 1 1/2" bolts with 3/8" lock washers, attach to 3/8-16 nut plates inserted into the bumper opening. Use Loctite on all bolts. Do this on both sides.

BE SURE TO USE LOCTITE® RED ON ALL BOLTS BEFORE TIGHTENING. TIGHTEN ALL BOLTS ACCORDING TO THE TORQUE CHART ON THE FRONT PAGE OF THESE INSTRUCTIONS OR ON PAGE 3 OF THE BASEPLATE TOWING GENERAL INSTRUCTIONS.



18. Attach the permanent baseplate safety cables to the provided convenience link on the baseplate (see grey arrow). On the passenger side, the quick link has to be on the outside of the frame because there is not enough room with the hose on the inside. The photo above shows the recommended installation of the cables to frame of vehicle (see white arrow). Additional options may interfere with suggested mounting; in this case secure the cables to a solid piece of the frame as described in the instructions included with the permanent baseplate safety cables. Be sure the safety cables do not rub against any hoses or moving parts. Do this to both sides of the vehicle.

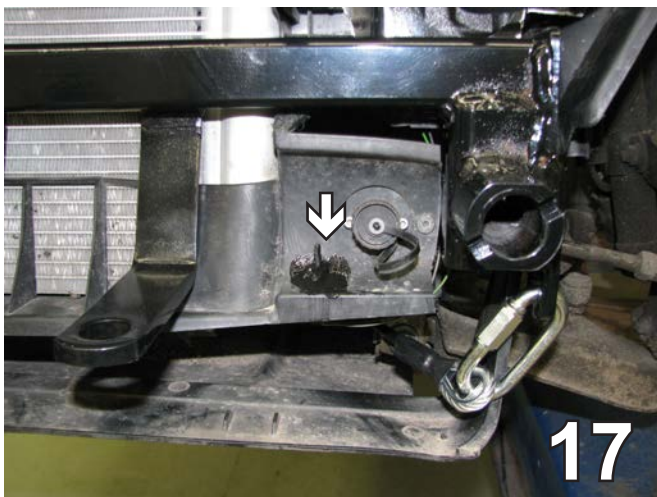

17. On the driver's side using the 13/32" drill bit, drill a new hole into the location shown and attach the temperature sensor.

19. Reinstall the tires, bumper, headlights, fascia, grille, antenna, bolts and push pins.

BX1990

2006 Mercedes Smart for two CDI

Installation Instructions

Install the tow bar and safety cables according to the instructions included in their packages.

Do not substitute other devices if the tow bar pin and clip are lost.

DEALER OR INSTALLER: BE CERTAIN THE USER RECEIVES THE INSTRUCTION SHEETS.

Be sure that **ALL** electrical connections are plugged in properly and functioning **BEFORE** installing the fascia.

DEALER or INSTALLER:
Be certain the user receives the instruction sheets for their products.

CUSTOMER SERVICE COMMITMENT

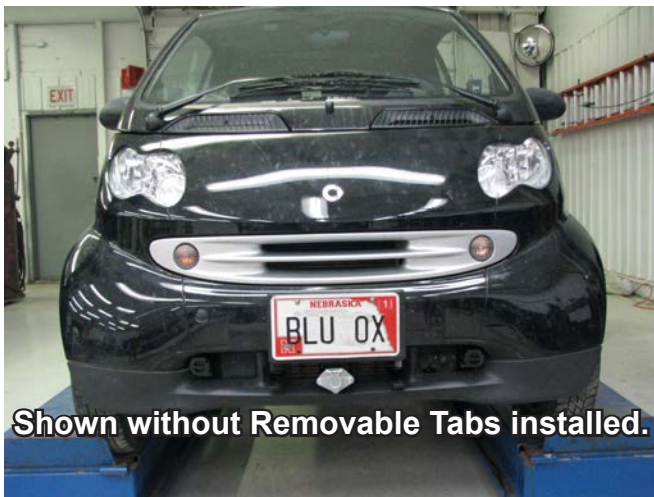

Shown without Removable Tabs installed.

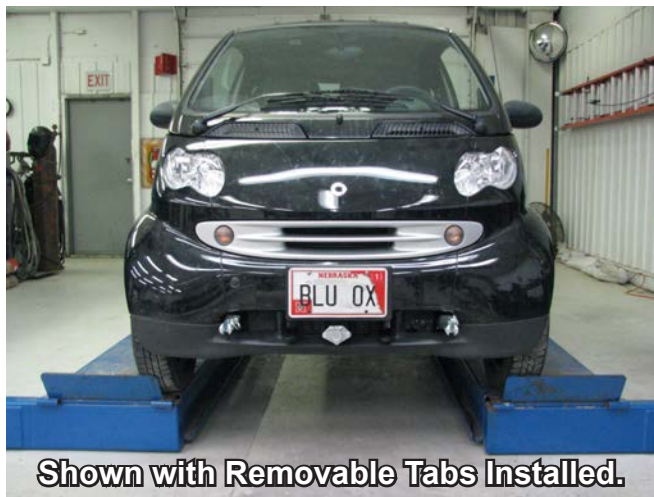

Shown with Removable Tabs Installed.

Blue Ox is committed to providing you with exceptional customer care throughout your lifetime with our products. Our team is here to assist you with any questions you may have regarding the performance of your product. Simply call 1-(402) 385-3051 and you can speak with our customer care team.

Additionally, please visit our website to see which rallies our Destination America team will be attending. For a nominal fee, our service technician will service your towing system to ensure it's in proper working condition. Also as a commitment to our customers, should you visit our factory you can stay at our full service Blue Ox campground at no charge along with enjoying a factory tour.

Again thank you for being our customer and for the confidence you have shown in the performance of our products. It is because of customers like you we enjoy the success we have today.

If the baseplate is in an accident, it must be replaced. **DO NOT** use it again! An accident can cause unseen damage and using it again could result in more damage or serious injury. **DO NOT** use the baseplate if it is damaged or missing parts.



© 2010 Blue Ox
One Mill Road, Industrial Park
Pender, Nebraska 68047
Phone: (402) 385-3051
Toll Free: (888) 425-5382
Fax: (402) 385-3360
www.blueox.com
7/28/17

General Information

1. Ensure that your product(s) are registered online at www.blueox.com. It is crucial to register your product(s) so that you may be alerted of product offerings, updates, upgrades, maintenance and safety bulletins, and/or recalls.
2. **It is the owner's responsibility to inspect all towing equipment for cracked welds, missing or worn parts and loose bolts before each towing trip.** Be sure to use Loctite® Red on all bolts and tighten to the recommended specifications.
3. **It is the owner's responsibility to hook up all towing equipment per manufacturer's instructions/recommendations.**
4. Remove the attachment tabs when not in use (if applicable).

Notice To Baseplate Installer

1. It is YOUR responsibility to watch for:

- Oil cooler and air conditioner lines
- Electrical wires and hoses
- Missing parts or attaching points on the frame

** If the baseplate is improperly installed and is against a wire or hose, it could cause fluid leaks or electrical shorts some time after the actual baseplate installation.

Permanent Baseplate Safety Cable Installation

Permanent baseplate safety cables are strongly recommended when towing a vehicle with a tow bar. The principle function of the permanent baseplate safety cables is to prevent the towed vehicle from breaking loose in the event the connection between the frame of the towed vehicle and the baseplate fails or becomes disconnected. The cables must be connected from the baseplate to the frame rail or cross member of the vehicle's frame. The illustrations below show the possible arrangements recommended by Blue Ox®. Each permanent baseplate safety cable must have an adequate weight rating for the towing system. The weight rating of the two (2) cables together will not qualify.

Do not mount the permanent baseplate safety cables against wires, hoses or brake lines.

These permanent baseplate safety cables should remain installed as long as the baseplate is installed on the vehicle. Permanent baseplate safety cables are to be used in conjunction with, and NOT a replacement for legally required safety cables attaching the towed vehicle to the towing vehicle.

OPTION #1

Permanent Baseplate Safety Cables to Cross Member or Frame of Towed Vehicle.

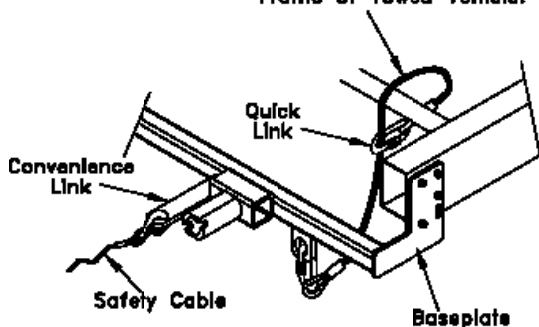

OPTION #2

Permanent Baseplate Safety Cables to Cross Member or Frame of Towed Vehicle.

