



Baseplate Installation Instructions

BX2242 2006-07 Honda Accord (Incl. LX, EX, DX) (no foglights)

Installation Instructions

Serial Number

Please read BOTH these Installation Instructions and the General Instructions before attempting to install or operate this equipment.

- Blue Ox® towing products and accessories are intended to be installed by Blue Ox® Dealers who are familiar with our products and have the equipment necessary and knowledge to do "fit work". When necessary Blue Ox® Dealers can be found at www.blueox.com or by contacting our Customer Care Department at (402) 385-3051.
- Many Blue Ox® Baseplates are designed to use existing holes and hardware to mount the baseplate to the towed vehicle. Even though bolts are there, do not assume they are adequate for baseplate mounting. Always use hardware supplied in the hardware kit and existing hardware specified in the Baseplate Installation Instructions.

Attachment Tab Height: 14"

Attachment Tab Width: 23"

Bolt Torque Specifications

Torque in Foot-Pounds for Metric Bolts

Bolt Size	Grade 8.8	Grade 10.9
6MM	6	8
8MM	16	22
10MM	31	40
12MM	54	70
14MM	89	117

Confirm the towability and pre-towing procedures for your vehicle with the owner's manual or contact the vehicle's manufacturer for specific towing procedures.

Bolt Torque Specifications

Torque in Foot-Pounds for Inch Bolts

Bolt Size	Grade 5	Grade 8
1/4"	10	14
5/16"	19	29
3/8"	33	47
7/16"	54	78
1/2"	78	119
5/8"	154	230



If the front of your vehicle looks different than this, call us at (402) 385-3051.

WARNING

Failure to read and follow these instructions could result in separation of the towed vehicle from the tow bar, causing property damage, loss of towed vehicle, personal injury or death.

BX2242 2006-07 Honda Accord

(Incl. LX, EX, DX) (no foglights)
Installation Instructions

Parts List

Ref. No.	Qty.	Part #	Description
1	1	61-6187	Weldment, Baseplate, BX2242
2	4	61-5208	Weldment, 3/8-16 Nut Plate, w/ 14" Wire
3	4	201-0440	3/8-16 x 1 1/2 Hex Bolt, Grd. 5, ZP
4	4	201-0368	3/8-16 x 1 1/4 Hex Bolt, Grd. 5, ZP
5	8	203-0010	3/8" Lock Washer, ZP
6	4	202-0003	3/8-16 Hex Nut, ZP
7	6	203-0003	3/8" Flat Washer, ZP
8	1	201-0655	6MM-1x30MM Hex Bolt, Grd. 8.8, ZP
9	1	203-0008	1/4" Lock Washer, ZP
10	1	203-0001	1/4" Flat Washer, ZP
11	2	201-0979	#12-14 x 1" Self Drilling Screw, ZP
12	2	201-0192	#10-32 x 1/2 Slot, Rd. Hd. Screw
13	2	203-0054	#10 Lock Washer
14	2	202-0047	#10-32 Hex Nut
15	2	101-5822	Adapter, 4 Way Connector
16	2	62-3468	Attachment, Assembly, SF/SB (R)
	2	226-0046	Baseplate Safety Cable, 36" CL III (Not Shown)
	4	229-0359	Quicklink, 3/8, ZP (Not Shown)
	2	290-0437	Cap Plug (Not Shown)

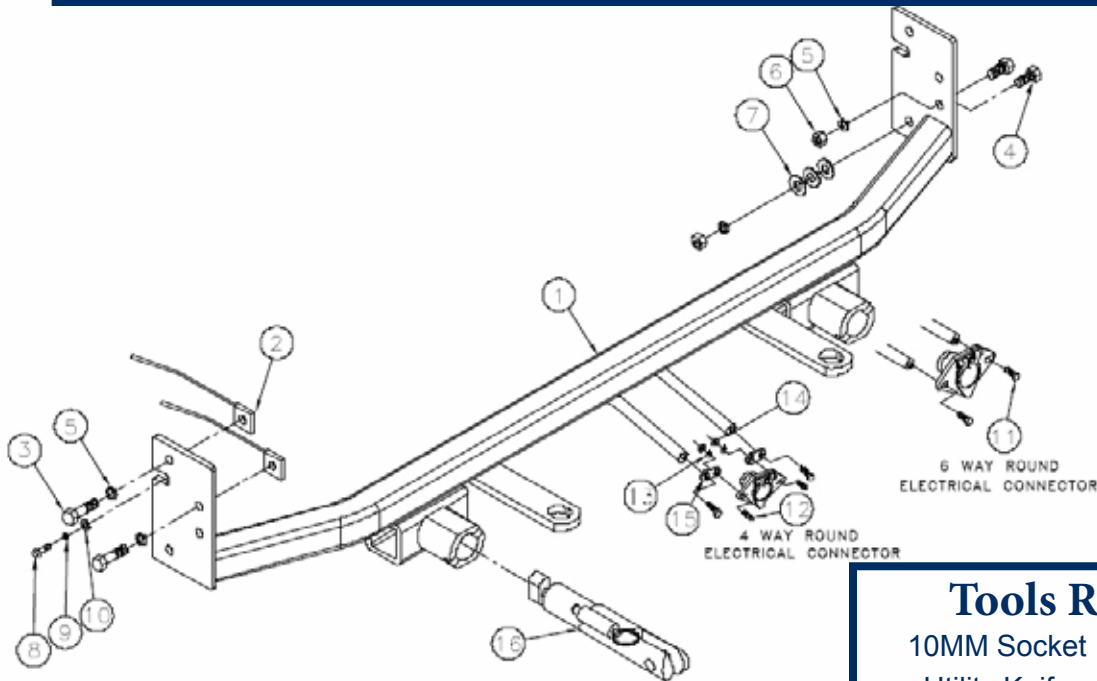

Tools Required

10MM Socket	13/32" Drill Bit
Utility Knife	Loctite® RED
Phillips Screw Driver	9/16" Socket
Reciprocating Saw	Vise Grip
12MM Socket	Tape Measure

Important:

Use only genuine factory replacement parts on your baseplate. Do **NOT** substitute homemade or non-typical parts. If a bolt is lost or in need of replacement, for your safety and the preservation of your baseplate, be sure to use a replacement bolt of the same grade (In most cases it will be Grade 5, please reference the parts list above). Replacement parts may be ordered through your nearest Blue Ox® Dealer or Distributor, or call our Customer Care Team at (402)385-3051. Failing to follow and/or altering these installation instructions in either installation or required equipment will void the manufacturer's warranty. Towing behind a non-motorized vehicle will void the warranty.

BX2242 2006-07 Honda Accord

(Incl. LX, EX, DX) (no foglights)

Installation Instructions

Attachment Tabs:

Due to the design of the removable tabs, the RangeFinder II, Adventurer and Ambassador tow bars can not be used. Adapters, except the BX8833 and BX88151, can not be used with this baseplate.

Instructions:

The front fascia, fascia brace and metal bumper are removed for the baseplate installation. Drilling is required. Headlights are removed and replaced for installation.

Some vehicles fascia's may need trimming. The dimensional variations between otherwise identical vehicles can be considerable. While the baseplate was designed for easy installation, it may be necessary to tailor the baseplate slightly to compensate for auto manufactures' tolerances. These minor adjustments may include filing a hole slightly, bending electrical rods or bending end plates.

The Bx8869 Bulb and Socket Wiring Kit is recommended for this vehicle.



1. Remove the Phillips head push pins, indicated by the white arrows in the photo above. Also remove five push pins from the front edge just above the grill and three push pins from the back edge of black plastic cover on the top side of the fascia. These are indicated by the grey arrows in the photo above lift cover and set aside to be reinstalled later.



2. Using 10MM socket remove two metric bolts from the lower edge of the fascia just forward of the front tire, as indicated by the white arrows in the photo above. Remove one push pin indicated by the grey arrow in the photo above. Do this to both sides of the vehicle, the driver's side is shown.



3. Remove four push pins from the lower edge of fascia and belly pan.

Handling of some cosmetic parts when installing this product may require the use of protective covers, rags, specialty tools, etc. to prevent damage.

BX2242

2006-07 Honda Accord

(Incl. LX, EX, DX) (no foglights)

Installation Instructions



4. Just forward of the front tire on fascia's corner, remove on Phillips head screw with the Phillips screw driver. Do this to both sides of the vehicle, the driver's side is shown. Pull the fascia corner out to the side of the vehicle and then forward to release, set fascia aside carefully.

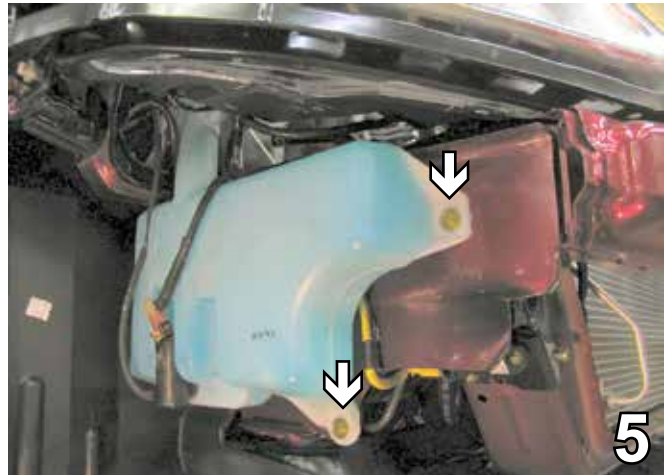

5. Using a 10MM socket remove two metric bolts from the washer reservoir. Do not remove the reservoir.

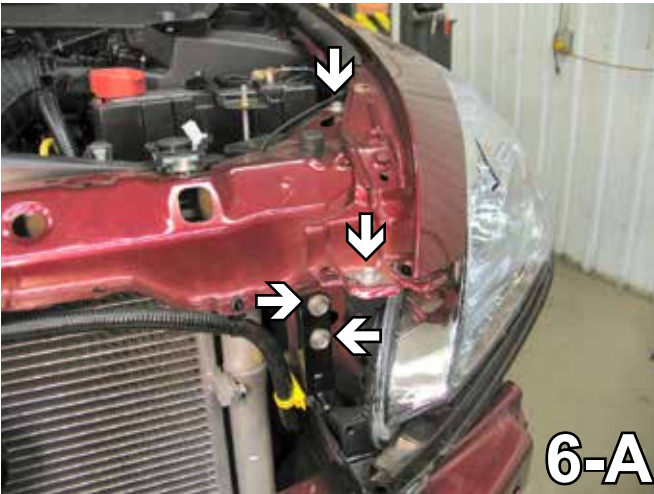

6. Using the 10MM socket, remove the four metric bolts from the top side of the head light assembly, indicated by the white arrows in the photo 6-A. Remove one metric bolt on the side, indicated by the grey arrow in the photo 6-B. Pull assembly forward disconnect electrical connections. This is done to both sides of the vehicle, the driver's side is shown. Set headlights aside to be reinstalled later.

BX2242 2006-07 Honda Accord

(Incl. LX, EX, DX) (no foglights)

Installation Instructions



7. Using a 12mm socket remove two metric bolts from the top of the metal bumper and on the bottom. Pull the metal bumper forward and set carefully aside. This is done to both sides, the driver's side is shown.

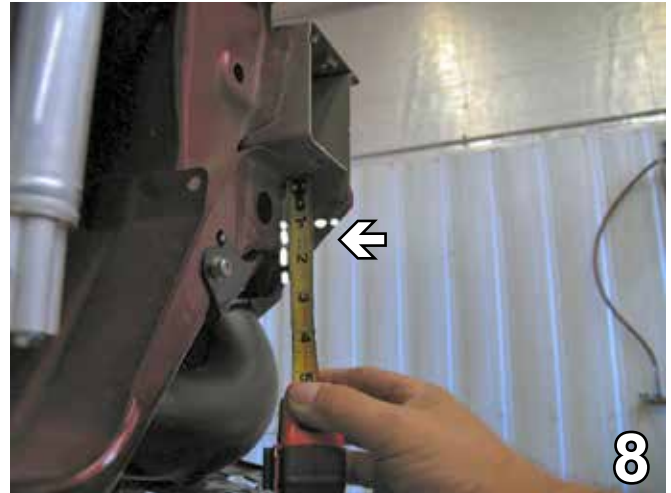

8. Measure 1 1/4" down from the bottom of the frame rail. Make a horizontal mark on the webbing back to cross member and down. Using a reciprocating saw remove this portion of the frame. Do this on both sides, the driver's side is shown.

BE SURE TO USE LOCTITE® RED ON ALL BOLTS BEFORE TIGHTENING. TIGHTEN ALL BOLTS ACCORDING TO THE TORQUE CHART ON THE FRONT PAGE OF THESE INSTRUCTIONS OR ON PAGE 3 OF THE BASEPLATE TOWING GENERAL INSTRUCTIONS.



9. Slide the baseplate in to the frame rail, align the front edge of the baseplate with the end of the frame and clamp to lower webbing with the vise grips. Using the baseplate as a template, drill four holes into the frame with the 13/32" drill bit. Insert 3/8-16 nut plate inside the end of the frame to align with the two upper drill holes, tighten the 3/8-16 hex bolts and the 3/8" lock washers. Do this on both sides of the vehicle. Insert the three flat washers between lower frame webbing and baseplate to align with lower drilled hole. Insert the 3/8-16 x 1 1/4 hex bolt into lower hole on baseplate, flat washers, drill hole on webbing, tighten the 3/8-16 hex nut and lock washer. Do this on both sides of the vehicle, the driver's side is shown.

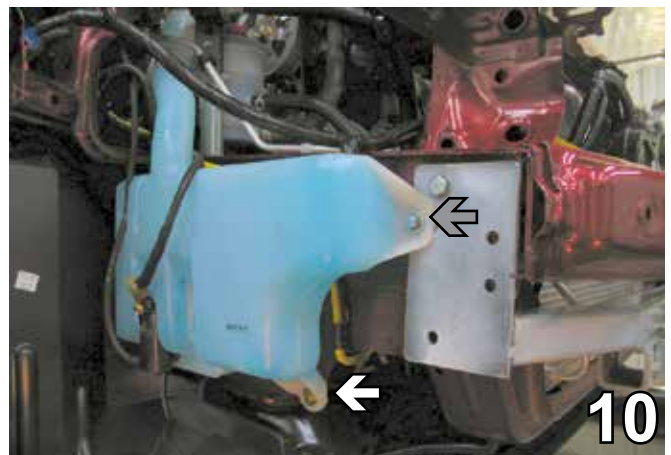

10. Reinstall lower washer reservoir bolt with existing bolt, indicated by the white arrow in the photo above. Use a 6MM-1 x 30MM hex bolt, 1/4" lock washer and 1/4" flat washer for the front bolt's location, indicated by the grey arrow in the photo above.

When using power drills be aware of the dangers of torque and drill bit length.

BX2242

2006-07 Honda Accord

(Incl. LX, EX, DX) (no foglights)

Installation Instructions

Be sure that ALL electrical connections are plugged in properly and functioning BEFORE Installing the fascia.

11. Reinstall metal bumper and fascia.
12. Install the tow bar and safety cables according to the instructions when demonstrating this to the customer. Be sure to include all the contents and packages.
13. Do **NOT** substitute other devices if the tow bar pins and clips are misplaced.

DEALER or INSTALLER:

Be certain the user receives the instructions sheets for their products.

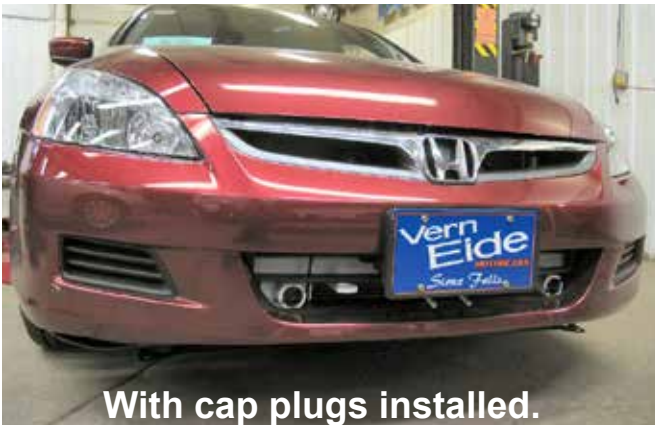

CUSTOMER SERVICE COMMITMENT

Blue Ox is committed to providing you with exceptional customer care throughout your lifetime with our products. Our team is here to assist you with any questions you may have regarding the performance of your product. Simply call (402) 385-3051 and you can speak with our customer care team.

Additionally, please visit our website to see which rallies our Destination America team will be attending. For a nominal fee, our service technician will service your towing system to ensure it's in proper working condition. Also as a commitment to our customers, should you visit our factory you can stay at our full service Blue Ox campground at no charge along with enjoying a factory tour.

Again thank you for being our customer and for the confidence you have shown in the performance of our products. It is because of customers like you we enjoy the success we have today.



If the baseplate is in an accident, it must be replaced. DO NOT use it again! An accident can cause unseen damage and using it again could result in more damage or serious injury. DO NOT use the baseplate if it is damaged or missing parts.

© 2005, 10 Blue Ox
One Mill Road, Industrial Park
Pender, Nebraska 68047
Phone: (402) 385-3051
Fax: (402) 385-3360
www.blueox.com

General Information

1. Ensure that your product(s) are registered online at www.blueox.com. It is crucial to register your product(s) so that you may be alerted of product offerings, updates, upgrades, maintenance and safety bulletins, and/or recalls.
2. **It is the owner's responsibility to inspect all towing equipment for cracked welds, missing or worn parts and loose bolts before each towing trip.** Be sure to use Loctite® Red on all bolts and tighten to the recommended specifications.
3. **It is the owner's responsibility to hook up all towing equipment per manufacturer's instructions/recommendations.**
4. Remove the attachment tabs when not in use (if applicable).

Notice To Baseplate Installer

1. It is YOUR responsibility to watch for:

- Oil cooler and air conditioner lines
- Electrical wires and hoses
- Missing parts or attaching points on the frame

** If the baseplate is improperly installed and is against a wire or hose, it could cause fluid leaks or electrical shorts some time after the actual baseplate installation.

Permanent Baseplate Safety Cable Installation

Permanent baseplate safety cables are strongly recommended when towing a vehicle with a tow bar. The principle function of the permanent baseplate safety cables is to prevent the towed vehicle from breaking loose in the event the connection between the frame of the towed vehicle and the baseplate fails or becomes disconnected. The cables must be connected from the baseplate to the frame rail or cross member of the vehicle's frame. The illustrations below show the possible arrangements recommended by Blue Ox®. Each permanent baseplate safety cable must have an adequate weight rating for the towing system. The weight rating of the two (2) cables together will not qualify.

Do not mount the permanent baseplate safety cables against wires, hoses or brake lines.

These permanent baseplate safety cables should remain installed as long as the baseplate is installed on the vehicle. Permanent baseplate safety cables are to be used in conjunction with, and NOT a replacement for legally required safety cables attaching the towed vehicle to the towing vehicle.

OPTION #1

Permanent Baseplate Safety Cables to Cross Member or Frame of Towed Vehicle.

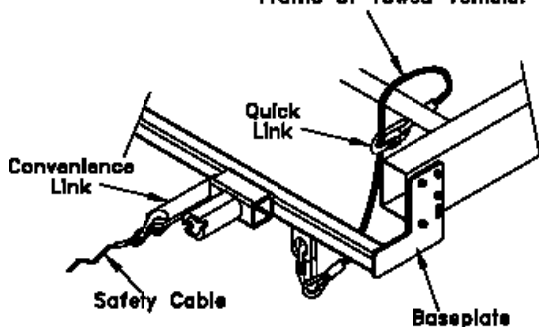

OPTION #2

Permanent Baseplate Safety Cables to Cross Member or Frame of Towed Vehicle.

