



## BX2726

# 2014-19 Kia Soul (No Foglights) Installation Instructions

**Attachment Tab Height: 13-1/2"**

**Attachment Tab Width: 24"**

**Serial Number**

**Please read BOTH these Installation Instructions and the General Instructions prior to installing or operating this equipment.**

- Blue Ox® towing products and accessories are intended to be installed by Blue Ox® Dealers who are familiar with our products and have the equipment and knowledge necessary to do "fit work". If needed, Blue Ox® Dealers can be found at [www.blueox.com](http://www.blueox.com) or by contacting our Technical Service Department at (402) 385-3051.
- Many Blue Ox® baseplates are designed to use existing holes and hardware to mount the baseplate to the towed vehicle. Even though bolts are there, do not assume they are adequate for baseplate mounting. Always use the hardware supplied in the hardware kit and existing hardware as specified in the installation instructions.

### Bolt Torque Specifications

Torque in Foot-Pounds for Inch Bolts

Bolt Size	Grade 5	Grade 8
1/4"	10	14
5/16"	19	29
3/8"	33	47
7/16"	54	78
1/2"	78	119
5/8"	154	230
3/4"	257	380



2017-2019

### Bolt Torque Specifications

Torque in Foot-Pounds for Metric Bolts

Bolt Size	Grade 8.8	Grade 10.9
6MM	6	8
8MM	16	22
10MM	31	40
12MM	54	70
14MM	89	117
16MM	161	230
18MM	222	318



2014-2016

**Reference your vehicle owner's manual for manufacturer's towing specifications.**



## WARNING

Failure to read and follow these instructions could result in separation of the towed vehicle from the tow bar, causing property damage, loss of towed vehicle, personal injury or death.

If the front of your vehicle looks different than this, please contact us at (402)385-3051.

BX2726  
2014-19 Kia Soul (No Foglights)  
Installation Instructions

**Instruction Notes:** The fascia, air baffle, bumper and windshield washer fluid reservoir are removed and reinstalled for the baseplate installation. Some drilling and trimming is required.

Place all components that are removed on a flat, sturdy surface. All items will be reinstalled unless otherwise noted after the baseplate is installed.

The dimensional variations between otherwise identical vehicles can be considerable. While the baseplate was designed for easy installation, it may be necessary to tailor the baseplate slightly to compensate for vehicle manufacturer's tolerances.

The BX8869 Tail Light Wiring Kit is recommended for this vehicle.

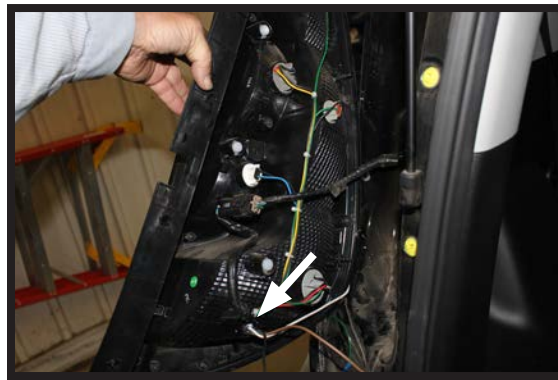

Drill a hole according to the tail  
light wiring kit instructions.

### **NOTICE**

- Handling of some cosmetic parts when installing this product may require the use of protective covers, rags, specialty tools, etc. to prevent damage.
- When using power drills be aware of the dangers of torque and drill bit length.
- When using a reciprocating saw be aware of objects behind the cutting surface.
- Use a good quality paint to spray cut edges of frame to prevent rusting.
- Be sure that **ALL** electrical connections are plugged in and accessories are functioning properly before reinstalling the fascia.
- The baseplate is computer tested to your vehicle's GVWR, exceeding this weight will void the manufacturer's warranty.
- Be sure to use Loctite® Red on all bolts before tightening. Tighten all bolts according to the torque chart provided.
- Dealer or installer be certain the user receives these instruction sheets.
- If the baseplate is in an accident, it must be replaced. **DO NOT** use it again! An accident can cause unseen damage and using it again could result in more damage or serious injury. **DO NOT** use the baseplate if it is damaged or missing parts.

# BX2726

## 2014-19 Kia Soul (No Foglights)

### Installation Instructions

#### Tools Required

Large Vise Grip  
 Flat Screwdriver  
 Utility Knife  
 Phillips Screwdriver  
 Torque Wrench  
 Drill  
 Reciprocating Saw  
 Tape Measure  
 Loctite® RED  
 1/4" Drill Bit  
 13/32" Drill Bit  
 8MM Socket  
 10MM Socket  
 12MM Socket  
 9/16" Socket

#### NOTE:

ITEMS 10 & 14  
 ARE TO BE USED  
 TO REATTACH THE  
 WINDSHIELD WASHER  
 TANK

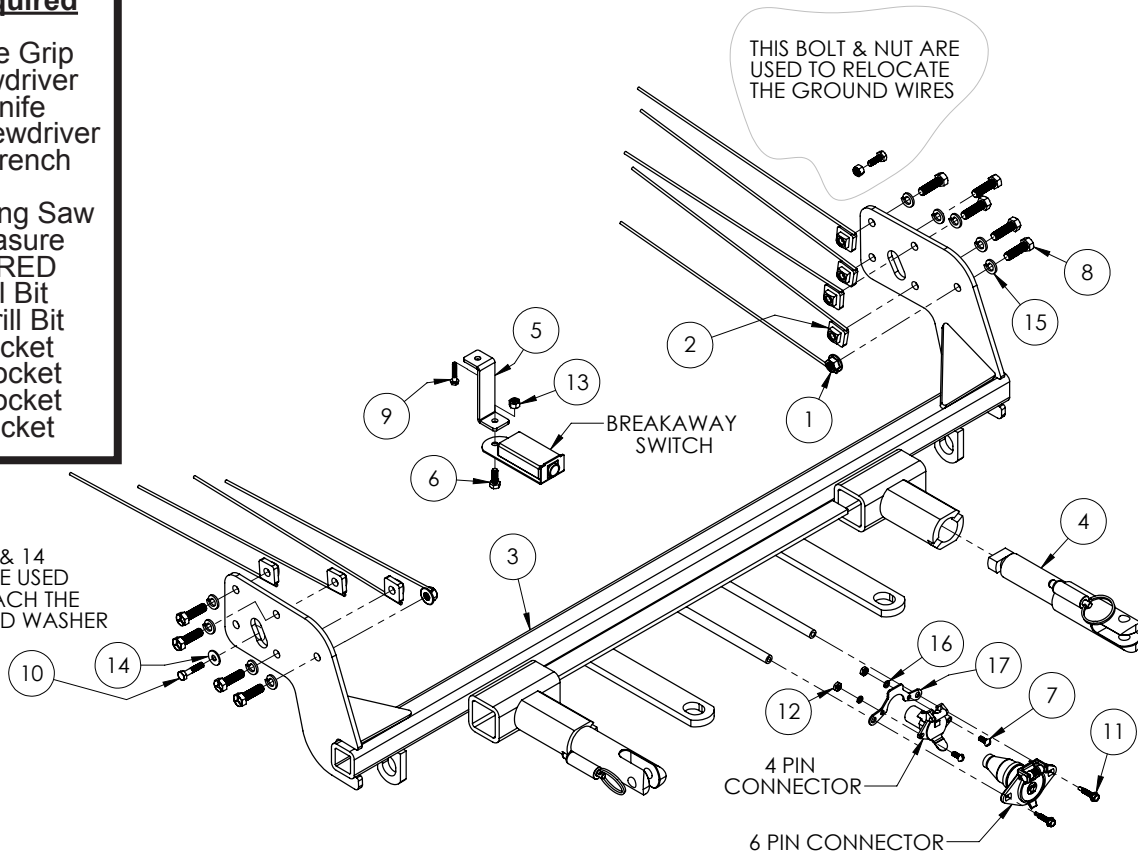

Item No.	Part No.	Description	Qty.
1.....	61-4978.....	3/8"-16 Whiz Nut w/ 14" Wire.....	2
2.....	61-5208.....	3/8"-16 Nut Plate w/ 14" Wire.....	7
3.....	61-7353.....	BX2726 Baseplate.....	1
4.....	62-3469.....	Attachment Tab Assembly with Hole.....	2
5.....	102-7168.....	Breakaway Bracket.....	1
6.....	201-0050.....	1/4"-20 x 3/4" Hex Head Bolt, Grade 5, ZP.....	2
7.....	201-0192.....	#10-32 1/2" Round Slotted Head Screw.....	2
8.....	201-0368.....	3/8"-16 x 1-1/4" Hex Head Bolt, Grade 5, ZP.....	9
9.....	201-0654.....	#10-16 x 1" Self Drilling Screw, ZP.....	1
10.....	201-0655.....	6MM-1.0 x 30MM Hex Head Bolt, Grade 8.8, ZP.....	1
11.....	201-0979.....	#12-14 x 1" Self Drilling Screw, ZP.....	2
12.....	202-0047.....	#10-32 Hex Nut.....	2
13.....	202-0102.....	1/4"-20 Hex Nylon Nut, ZP.....	2
14.....	203-0001.....	1/4" Flat Washer, ZP.....	1
15.....	203-0010.....	3/8" Lock Washer, ZP.....	9
16.....	203-0054.....	#10 Lock Washer, ZP.....	2
17.....	299-0685.....	Electrical Bracket, ZP.....	1
18.....	226-0046(not shown).....	Class III Safety Cables.....	2
19.....	229-0359(not shown).....	3/8" Quicklink, ZP.....	2
20.....	290-0437(not shown).....	Black Cap Plug Receiver.....	2

#### Important:

Use only genuine factory replacement parts on your baseplate. Do **NOT** substitute homemade or non-typical parts. If a bolt is lost or in need of replacement, for your safety and the preservation of your baseplate, be sure to use a replacement bolt of the same grade (In most cases it will be Grade 5, please reference the parts list above). Replacement parts may be ordered through your nearest Blue Ox® Dealer or Distributor. Failing to follow and/or altering these installation instructions in either installation or required equipment will void the manufacturer's warranty. Towing behind a non-motorized vehicle will void the warranty.

BX2726  
2014-19 Kia Soul (No Foglights)  
Installation Instructions



1. Using a 10MM socket, remove the two (2) screws from the top edge of the fascia (gray). Then remove the five (5) push pins (white).

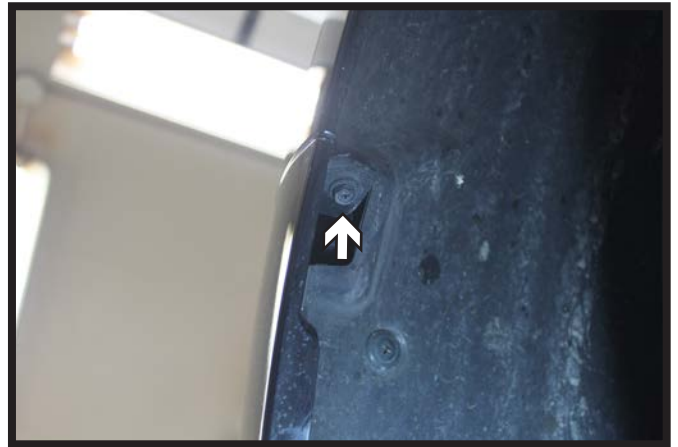

2. Using a 8MM socket, remove the screw from the top edge of the wheel well. Do this on both sides of the vehicle.  
**Note: For 2017 & newer models use a 10MM socket.**

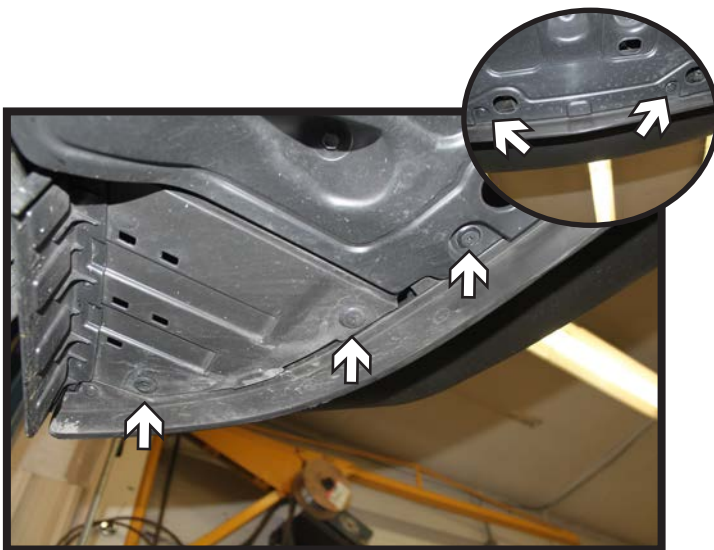

3. Remove the eight (8) push pins from the underside of the fascia. There are three (3) on each side and two (2) in the middle. Remove the fascia from the vehicle, disconnecting any electrical connections and set aside.

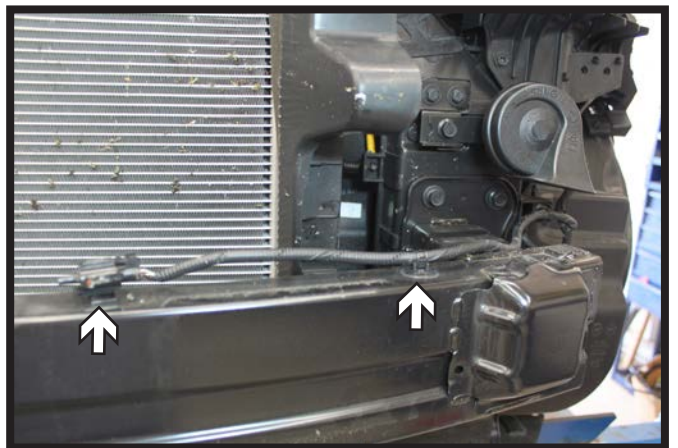

4. Disconnect the temperature sensor from the top side of the bumper and set aside.

BX2726  
2014-19 Kia Soul (No Foglights)  
Installation Instructions

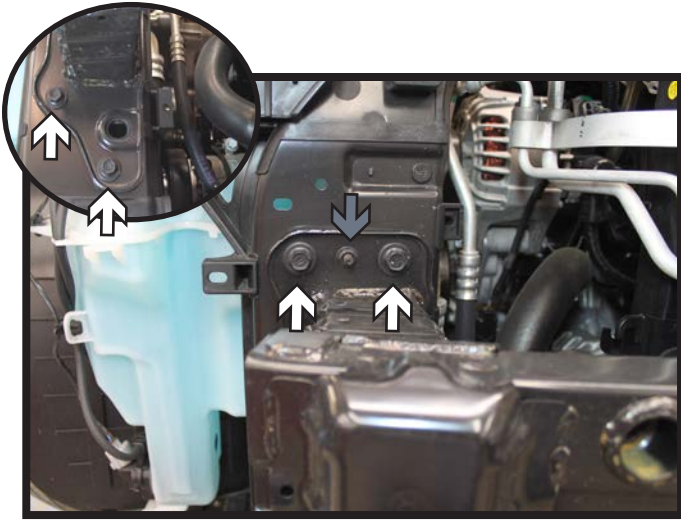

5. Using a 12MM socket, remove the four (4) screws from the bumper (white). Then using a 10MM socket, remove the nut (gray). Do this on both sides of the vehicle. Set the bumper aside.



6. Using a 10MM socket, remove the two (2) screws from the washer reservoir (white). Then using a phillips screwdriver, remove the screw from the front of the washer reservoir (gray). Disconnect/plug all lines and set reservoir aside.

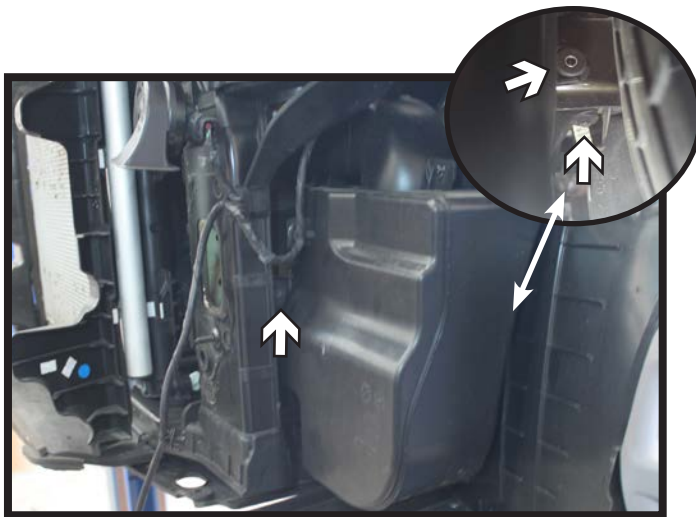

7. Using a 10MM socket, remove the three (3) screws from the air baffle. There are two (2) on the backside (inset) and one (1) in front. Disconnect the baffle and set aside.

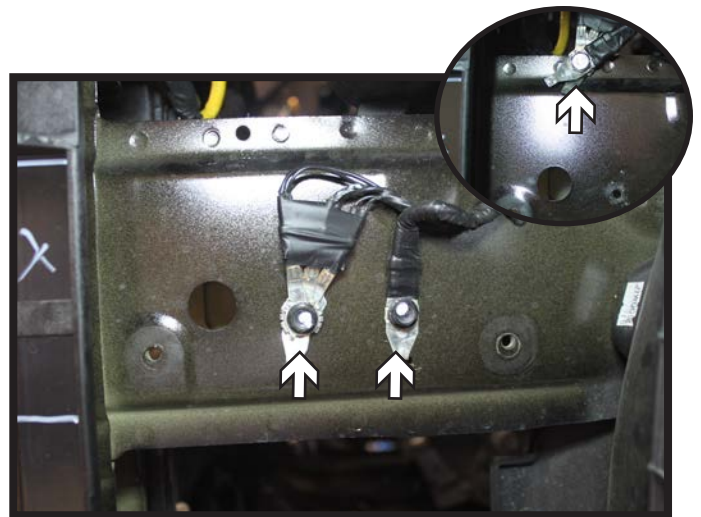

8. Using a 10MM socket, remove the two (2) ground wire screws from the side of the frame.  
Using a 1/4" drill bit, drill a hole thru the upper frame flange and secure the ground wires with the supplied 1/4"-20 x 3/4" bolt and lock nut (inset).

BX2726  
2014-19 Kia Soul (No Foglights)  
Installation Instructions



9. Using a reciprocating saw, remove the area just below the knob down just below the factory hole and back flush to the side of the frame. Do this on both sides of the vehicle.



10. Temporarily reinstall the bumper and trace the backside along the frame cuts on both sides. Remove the bumper and trim the marked areas with a reciprocating saw.

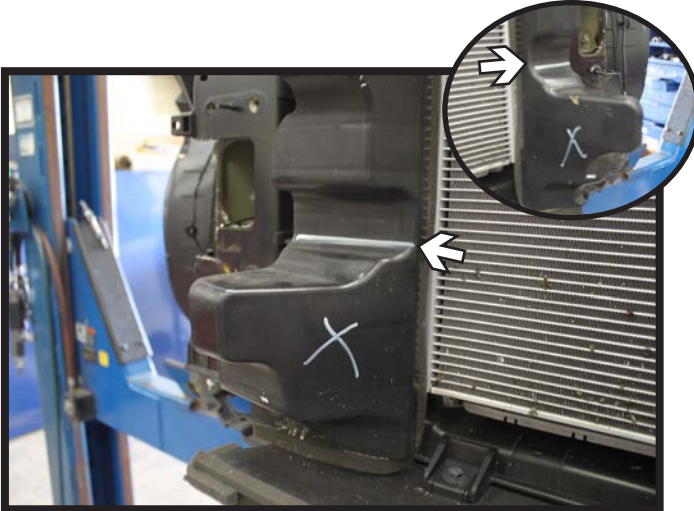

11. Trim off the lower sections of the plastic shrouding as shown on both sides of the vehicle for baseplate clearance.

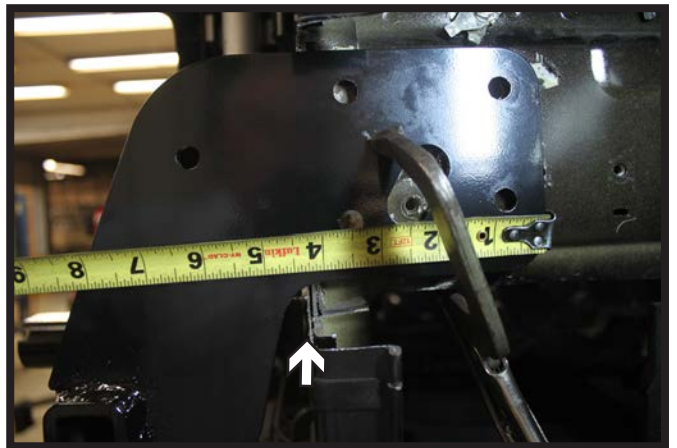

12. Position the baseplate onto the vehicle. Set the backside 4-1/4" from the face of the frame, level and clamp into position.

BX2726  
2014-19 Kia Soul (No Foglights)  
Installation Instructions



13. Using a 13/32" drill bit, drill the top back hole thru the frame. Install a 3/8"-16 x 1" bolt with lock washer into the hole and a 3/8" nut plate on the inside of the frame. Do this on both sides of the vehicle. Fully tighten all hardware.

Continue drilling the remaining two (2) holes on the passenger side and three (3) holes on the driver side thru the frame.

Note: The lower back hole on the passenger side will not be used due to clearance for the washer reservoir.

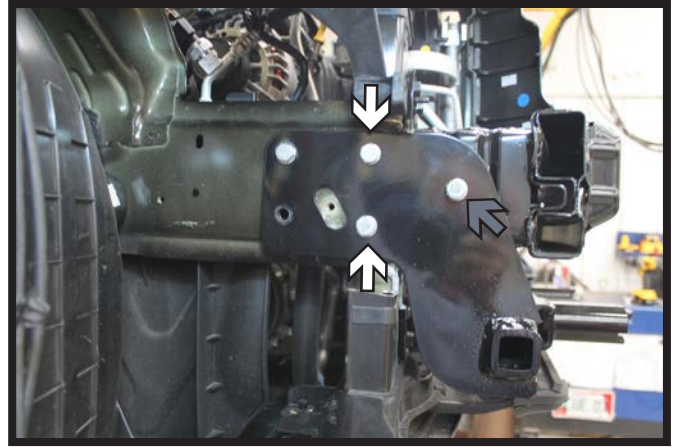

14. Install a 3/8"-16 x 1" bolts with lock washers into the holes and a 3/8" nut plates on the inside of the frame. Do this on both sides of the vehicle. Fully tighten all hardware.

Reinstall the bumper to the vehicle. Continue drilling the holes thru the bumper (gray). Install a 3/8"-16 x 1" bolt with lock washer into the holes and a 3/8" whiz nut on the inside of the bumper. Do this on both sides of the vehicle. Fully tighten all hardware.

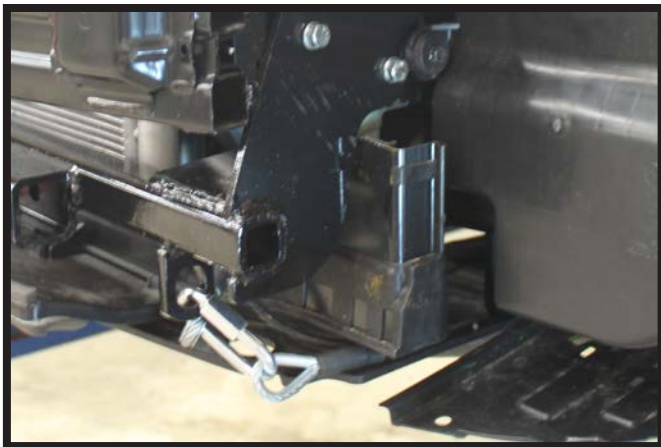

15. Attach the permanent baseplate safety cables to the provided convenience link on the baseplate. The photo shows the recommended installation of the cables to frame of vehicle. Additional options may interfere with suggested mounting; in this case, secure the cables to a solid piece of the frame as described in the instructions included with the permanent baseplate safety cables. Be sure the safety cables do not rub against any hoses or moving parts. Do this on **BOTH** sides of the vehicle.

BX2726  
2014-19 Kia Soul (No Foglights)  
Installation Instructions

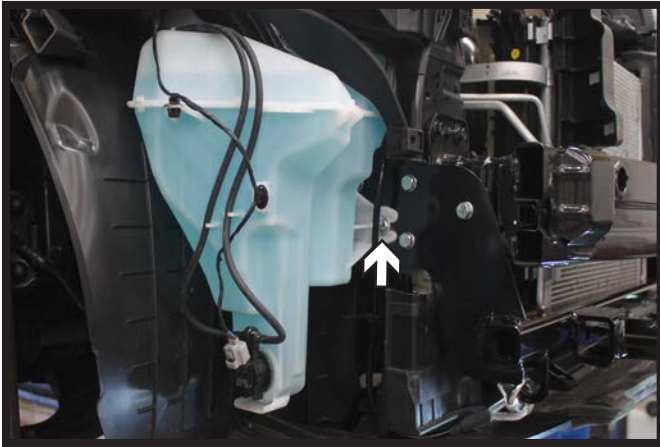

16. Reinstall the air baffle on the driver side.  
Reinstall the washer reservoir, using the supplied 6MM bolt and 1/4" flat washer.



17. Reinstall the front fascia.

## CUSTOMER SERVICE COMMITMENT

Blue Ox® is committed to providing you with exceptional customer care throughout your lifetime with our products. Our team is here to assist you with any questions you may have regarding the performance of your product. Simply call (402) 385-3051 and you can speak with our technical service team.

Additionally, please visit our website to see which rallies our Destination America team will be attending. For a nominal fee, our service technician will service your towing system to ensure it's in proper working condition. Also, as a commitment to our customers, should you visit our factory, you can stay at our full service Blue Ox® campground at no charge along with enjoying a factory tour.

Again, thank you for being our customer and for the confidence you have shown in the performance of our products. It is because of customers like you we enjoy the success we have today.

© 2015 Blue Ox  
One Mill Road, Industrial Park  
Pender, Nebraska 68047  
Phone: (402) 385-3051  
Fax: (402) 385-3360  
www.blueox.com



# General Information

1. Ensure that your product(s) are registered online at [www.blueox.com](http://www.blueox.com). It is crucial to register your product(s) so that you may be alerted of product offerings, updates, upgrades, maintenance and safety bulletins, and/or recalls.
2. **It is the owner's responsibility to inspect all towing equipment for cracked welds, missing or worn parts and loose bolts before each towing trip.** Be sure to use Loctite® Red on all bolts and tighten to the recommended specifications.
3. **It is the owner's responsibility to hook up all towing equipment per manufacturer's instructions/recommendations.**
4. Remove the attachment tabs when not in use (if applicable).

## Notice To Baseplate Installer

### 1. It is YOUR responsibility to watch for:

- Oil cooler and air conditioner lines
- Electrical wires and hoses
- Missing parts or attaching points on the frame

\*\* If the baseplate is improperly installed and is against a wire or hose, it could cause fluid leaks or electrical shorts some time after the actual baseplate installation.

## Permanent Baseplate Safety Cable Installation

Permanent baseplate safety cables are strongly recommended when towing a vehicle with a tow bar. The principle function of the permanent baseplate safety cables is to prevent the towed vehicle from breaking loose in the event the connection between the frame of the towed vehicle and the baseplate fails or becomes disconnected. The cables must be connected from the baseplate to the frame rail or cross member of the vehicle's frame. The illustrations below show the possible arrangements recommended by Blue Ox®. Each permanent baseplate safety cable must have an adequate weight rating for the towing system. The weight rating of the two (2) cables together will not qualify.

***Do not mount the permanent baseplate safety cables against wires, hoses or brake lines.***

These permanent baseplate safety cables should remain installed as long as the baseplate is installed on the vehicle. Permanent baseplate safety cables are to be used in conjunction with, and NOT a replacement for legally required safety cables attaching the towed vehicle to the towing vehicle.

### OPTION #1



### OPTION #2

