



BX3616

2009-13 Subaru Forester Installation Instructions

Serial Number

Attachment Tab Height: 17-1/2"

Attachment Tab Width: 18"

Please read BOTH these Installation Instructions and the General Instructions prior to installing or operating this equipment.

- Blue Ox® towing products and accessories are intended to be installed by Blue Ox® Dealers who are familiar with our products and have the equipment and knowledge necessary to do "fit work". If needed, Blue Ox® Dealers can be found at www.blueox.com or by contacting our Customer Care Department at (402) 385-3051.
- Many Blue Ox® baseplates are designed to use existing holes and hardware to mount the baseplate to the towed vehicle. Even though bolts are there, do not assume they are adequate for baseplate mounting. Always use the hardware supplied in the hardware kit and existing hardware as specified in the installation instructions.



If the front of your vehicle looks different than this, please contact us at (402)385-3051.

Reference your vehicle owner's manual for manufacturer's towing specifications.

Bolt Torque Specifications
Torque in Foot-Pounds for Metric Bolts

Bolt Size	Grade 8.8	Grade 10.9
6MM	6	8
8MM	16	22
10MM	31	40
12MM	54	70
14MM	89	117

Bolt Torque Specifications
Torque in Foot-Pounds for Inch Bolts

Bolt Size	Grade 5	Grade 8
1/4"	10	14
5/16"	19	29
3/8"	33	47
7/16"	54	78
1/2"	78	119
5/8"	154	230

! WARNING

Failure to read and follow these instructions could result in separation of the towed vehicle from the tow bar, causing property damage, loss of towed vehicle, personal injury or death.

BX3616
2009-13 Subaru Forester
Installation Instructions

Instruction Notes: The fascia and metal bumper are removed and reinstalled for the baseplate installation. Some drilling and trimming is required.

Place all components that are removed on a flat, sturdy surface. All items will be reinstalled unless otherwise noted after the baseplate is installed.

The dimensional variations between otherwise identical vehicles can be considerable. While the baseplate was designed for easy installation, it may be necessary to tailor the baseplate slightly to compensate for vehicle manufacturer's tolerances.

The BX8869 Tail Light Wiring Kit is recommended for 2011-13 models.

The BX8848 4-Diode Wiring Kit is recommended for 2009-10 models.

NOTICE

- Handling of some cosmetic parts when installing this product may require the use of protective covers, rags, specialty tools, etc. to prevent damage.
- When using power drills be aware of the dangers of torque and drill bit length.
- When using a reciprocating saw be aware of objects behind the cutting surface.
- Use a good quality paint to spray cut edges of frame to prevent rusting.
- Be sure that **ALL** electrical connections are plugged in and accessories are functioning properly before reinstalling the fascia.
- Do not use the towed vehicle for storing luggage, equipment, etc. This may cause you to exceed the towing capacity of the tow bar, baseplate and its accessories.
- Be sure to use Loctite® Red on all bolts before tightening. Tighten all bolts according to the torque chart provided.
- Dealer or installer be certain the user receives these instruction sheet.
- If the baseplate is in an accident, it must be replaced. **DO NOT** use it again! An accident can cause unseen damage and using it again could result in more damage or serious injury. **DO NOT** use the baseplate if it is damaged or missing parts.

BX3616
2009-13 Subaru Forester
Installation Instructions

- Tools Required**

 - Flat Screwdriver
 - Utility Knife
 - Torque Wrench
 - Drill
 - Reciprocating Saw
 - Tape Measure
 - Loctite® RED
 - 13/32" Drill Bit
 - 17/32" Drill Bit
 - 10MM Socket
 - 14MM Socket
 - 9/16" Socket
 - 3/4" Socket
 - 3/8" Nut Driver
 - Flat Chisel

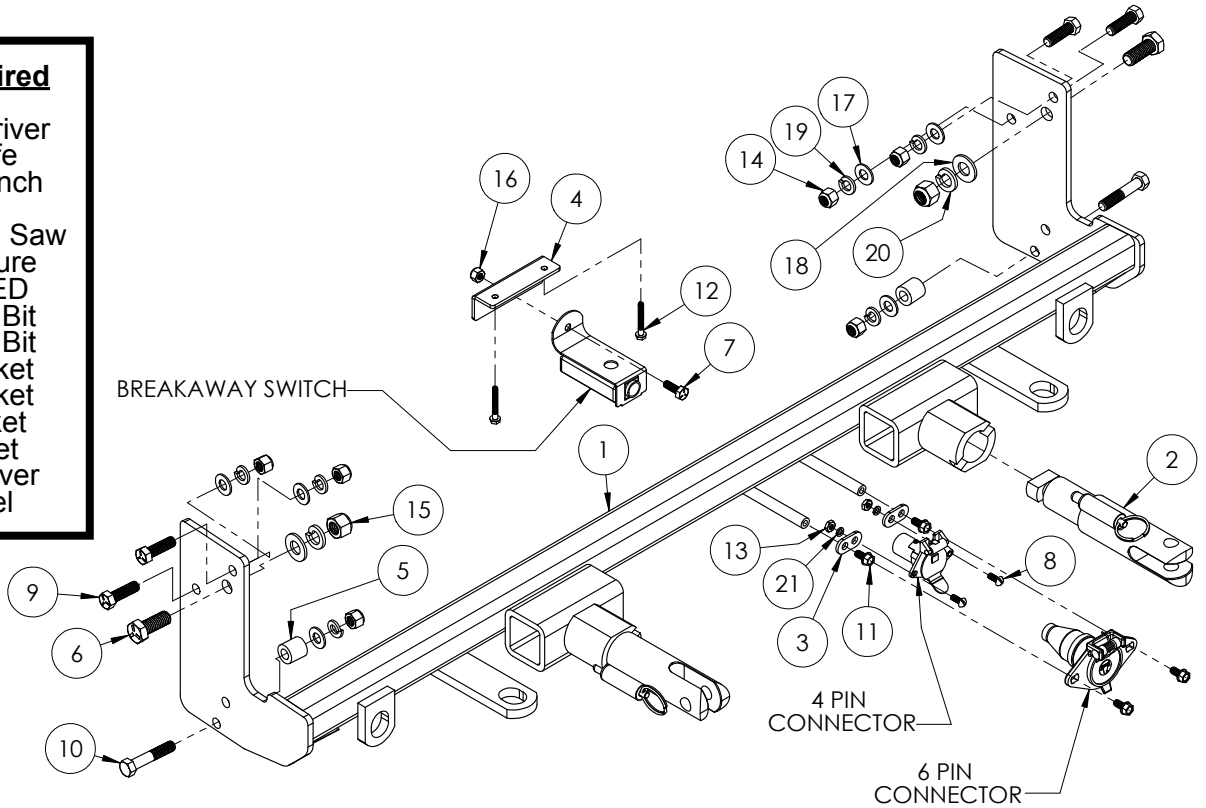

Item No.	Part No.	Description	Qty.
1.....	61-6551	BX3616 Baseplate.....	1
2.....	62-3468	Attachment Tab Assembly with Hole	2
3.....	101-5822	4 Way Connector Adapter	2
4.....	102-7159	Breakaway Bracket	1
5.....	107-1753	Spacer Tube, 3/4"Dia	2
6.....	201-0011	1/2"-13 x 1-1/4" Hex Head Bolt, Grade 5, ZP	2
7.....	201-0050	1/4"-20 x 3/4" Hex Head Bolt, Grade 5, ZP	1
8.....	201-0192	#10-32 1/2" Round Slotted Head Screw.....	2
9.....	201-0368	3/8"-16 x 1-1/4" Hex Head Bolt, Grade 5, ZP	4
10.....	201-0444	3/8"-16 x 2" Hex Head Bolt, Grade 5, ZP	2
11.....	201-0654	#10-16 x 1" Self Drilling Screw	2
12.....	201-0979	#12-14 x 1" Self Drilling Screw, ZP.....	2
13.....	202-0047	#10-32 Hex Nut	2
14.....	202-0090	3/8"-16 Hex Nylon Insert Lock Nut, ZP	6
15.....	202-0094	1/2"-13 Hex Nylon Lock Nut, ZP.....	2
16.....	202-0102	1/4"-20 Hex Nylon Nut, ZP	1
17.....	203-0003	3/8" Flat Washer, ZP.....	6
18.....	203-0005	1/2" Flat Washer, ZP.....	2
19.....	203-0010	3/8" Lock Washer, ZP	6
20.....	203-0012	1/2" Lock Washer, ZP	2
21.....	203-0054	#10 Lock Washer, ZP	2
22.....	226-0046(not shown)	Class III Safety Cables	2
23.....	229-0359(not shown)	3/8" Quicklink, ZP	2
24.....	290-0437(not shown)	Black Cap Plug Receiver.....	2

BX3616
2009-13 Subaru Forester
Installation Instructions



1. Using a flat screwdriver remove the six (6) push pins from the top edge of fascia. There are three (3) on each side.



2. Just forward the front tire, push the pin in the center to release. Do this to both sides of the vehicle.



3. Underneath in front of the tire, use a flat screwdriver to remove the push pin in the corner. Do this to both sides of the vehicle.

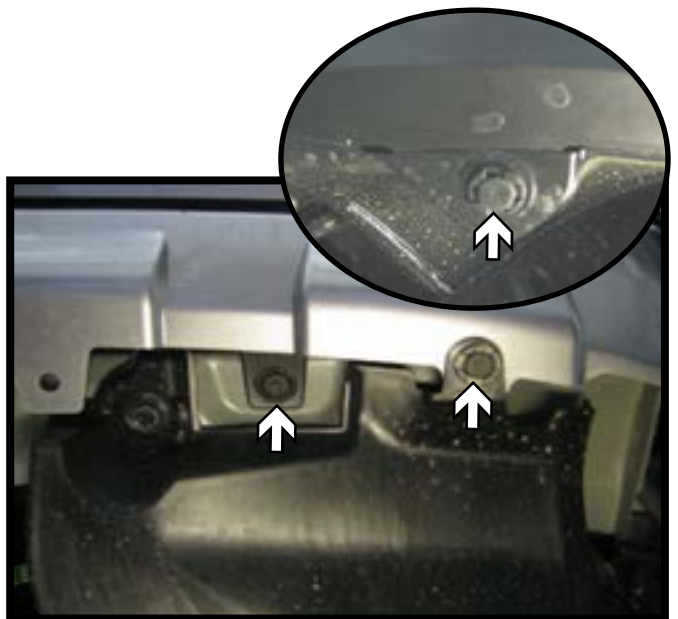

4. Using a flat screwdriver, remove six (6) push pins from the underside of the fascia. There is one (1) in front of the tire and two (2) in the towards the middle. Do this on both sides of the vehicle. Pull fascia corners outwards, then pull fascia forward to remove.

BX3616
2009-13 Subaru Forester
Installation Instructions

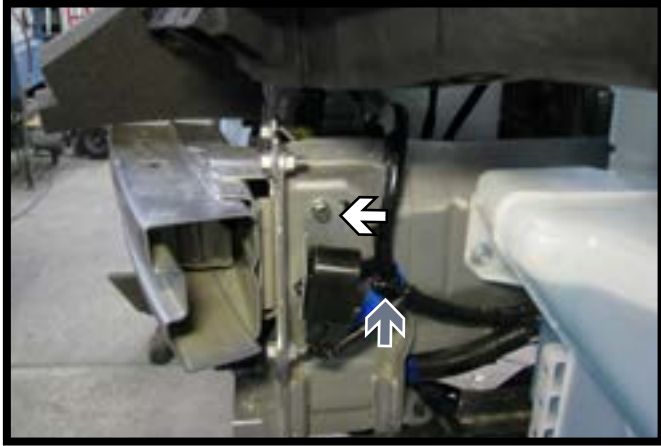

5. On the driver side, using a 10MM socket, remove the bolt above the sensor (white). Unplug the wiring (gray arrow).



6. On the passenger side, remove the wiring push pin.

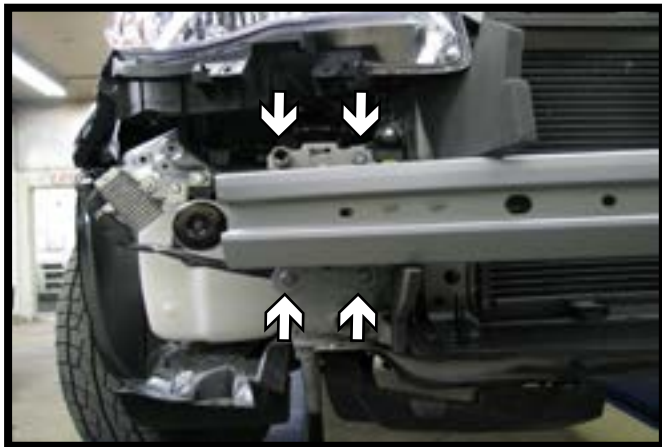

7. Remove the metal bumper, using a 12MM socket, remove the four (4) bolts from the bumper. Do this on both sides of the vehicle.

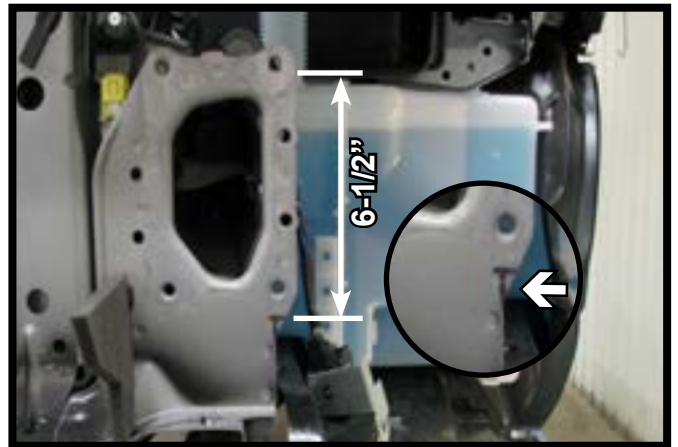

8. Using a reciprocating saw, make a notch down 6-1/2" from the top of the frame and flush with the lower outer flange of the frame. Do this on both sides of the vehicle.

BX3616
2009-13 Subaru Forester
Installation Instructions



9. Bend the temperature sensor backwards at an angle towards the radiator.



10. Using a 17/32" drill bit, ream out the existing hole in the frame as shown. Do this on both sides of the vehicle.

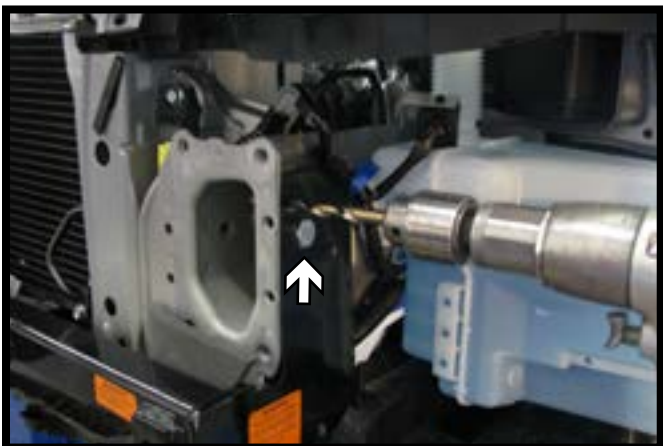

11. Tip the baseplate into position. Install 1/2"-13 x 1-1/4" bolts, 1/2" flat & lock washers and 1/2" lock nuts into the existing frame holes. Level the baseplate and tighten down the bolts.

Using a 13/32" drill bit, drill holes thru the frame using the baseplate as a template. Do this on both sides of the vehicle.

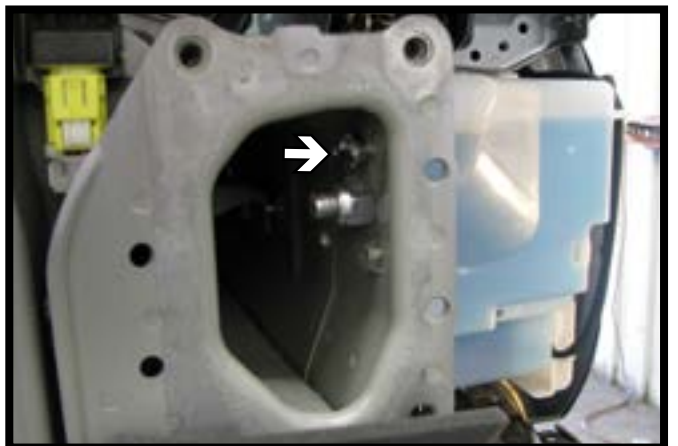

12. After drilling out the holes, use a flat chisel and knock off the nut on inside of the frame.

BX3616
2009-13 Subaru Forester
Installation Instructions



13. On the driver side, using a 13/32" drill bit, ream out the hole in the sensor bracket (white). Next flatten or trim off the alignment tab (gray).

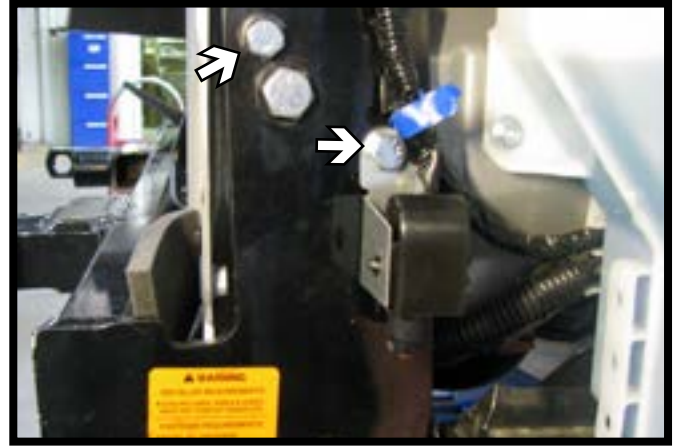

14. Install 3/8"-16 x 1-1/4" bolts, 3/8" flat & lock washers and 3/8" lock nuts into the top holes of the baseplate. Do this on both sides of the vehicle.
Note: On the driver side reattach the sensor with the 3/8" fasteners as shown.



15. On the bottom baseplate hole, insert the spacer tube between the frame and the baseplate. Insert a 3/8"-16 x 2" bolt, 3/8" flat & lock washer and 3/8" lock nut. Do this on both sides of the vehicle.



16. Attach the permanent baseplate safety cables to the provided convenience link on the baseplate. The photo above shows the recommended installation of the cables to frame of vehicle. Additional options may interfere with suggested mounting; in this case, secure the cables to a solid piece of the frame as described in the instructions included with the permanent baseplate safety cables. Be sure the safety cables do not rub against any hoses or moving parts. Do this on **BOTH** sides of the vehicle.

BX3616
2009-13 Subaru Forester
Installation Instructions



17. Reinstall the metal bumper with the existing bolts. Use two (2) 5/16" washers on bottom as spacers.

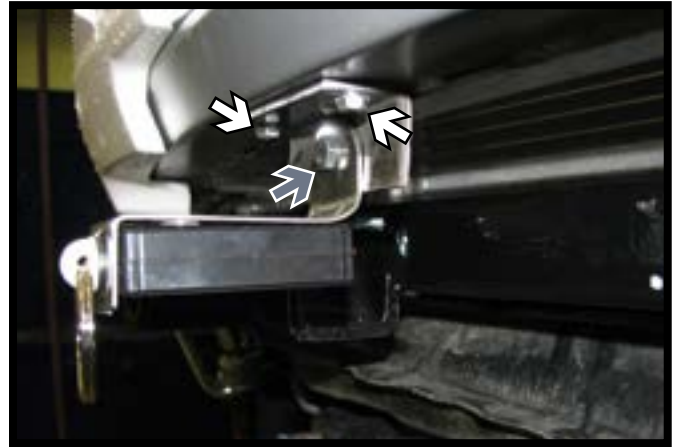

18. Optional: Attach the breakaway bracket to the underside of the bumper with two (2) #10-16 x 1" screws (white). Attach the breakaway to the bracket with a 1/4"-20 x 3/4" bolt and 1/4" nut (gray).



19. Hold the fascia as close to its original position and mark the backside of the fascia, trim as needed. Reinstall the fascia.

BX3616
2009-13 Subaru Forester
Installation Instructions



CUSTOMER SERVICE COMMITMENT

Blue Ox® is committed to providing you with exceptional customer care throughout your lifetime with our products. Our team is here to assist you with any questions you may have regarding the performance of your product. Simply call (402) 385-3051 and you can speak with our customer care team.

Additionally, please visit our website to see which rallies our Destination America team will be attending. For a nominal fee, our service technician will service your towing system to ensure it's in proper working condition. Also, as a commitment to our customers, should you visit our factory, you can stay at our full service Blue Ox® campground at no charge along with enjoying a factory tour.

Again, thank you for being our customer and for the confidence you have shown in the performance of our products. It is because of customers like you we enjoy the success we have today.

© 2012 Blue Ox
One Mill Road, Industrial Park
Pender, Nebraska 68047
Phone: (402) 385-3051
Fax: (402) 385-3360
www.blueox.com

General Information

1. Ensure that your product(s) are registered online at www.blueox.com. It is crucial to register your product(s) so that you may be alerted of product offerings, updates, upgrades, maintenance and safety bulletins, and/or recalls.
2. **It is the owner's responsibility to inspect all towing equipment for cracked welds, missing or worn parts and loose bolts before each towing trip.** Be sure to use Loctite® Red on all bolts and tighten to the recommended specifications.
3. **It is the owner's responsibility to hook up all towing equipment per manufacturer's instructions/recommendations.**
4. Remove the attachment tabs when not in use (if applicable).

Notice To Baseplate Installer

1. It is YOUR responsibility to watch for:

- Oil cooler and air conditioner lines
- Electrical wires and hoses
- Missing parts or attaching points on the frame

** If the baseplate is improperly installed and is against a wire or hose, it could cause fluid leaks or electrical shorts some time after the actual baseplate installation.

Permanent Baseplate Safety Cable Installation

Permanent baseplate safety cables are strongly recommended when towing a vehicle with a tow bar. The principle function of the permanent baseplate safety cables is to prevent the towed vehicle from breaking loose in the event the connection between the frame of the towed vehicle and the baseplate fails or becomes disconnected. The cables must be connected from the baseplate to the frame rail or cross member of the vehicle's frame. The illustrations below show the possible arrangements recommended by Blue Ox®. Each permanent baseplate safety cable must have an adequate weight rating for the towing system. The weight rating of the two (2) cables together will not qualify.

Do not mount the permanent baseplate safety cables against wires, hoses or brake lines.

These permanent baseplate safety cables should remain installed as long as the baseplate is installed on the vehicle. Permanent baseplate safety cables are to be used in conjunction with, and NOT a replacement for legally required safety cables attaching the towed vehicle to the towing vehicle.

OPTION #1

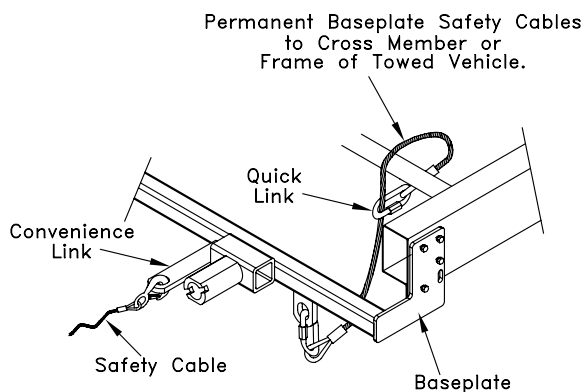

OPTION #2

