



Baseplate Installation Instructions

BX3823

2005-10 VW Jetta New Installation Instructions

Serial Number

Please read BOTH these Installation Instructions and the General Instructions before attempting to install or operate this equipment.

- Blue Ox® towing products and accessories are intended to be installed by Blue Ox® Dealers who are familiar with our products and have the equipment necessary and knowledge to do "fit work". When necessary Blue Ox® Dealers can be found at www.blueox.com or by contacting our Customer Care Department at (402) 385-3051.
- Many Blue Ox® Baseplates are designed to use existing holes and hardware to mount the baseplate to the towed vehicle. Even though bolts are there, do not assume they are adequate for baseplate mounting. Always use hardware supplied in the hardware kit and existing hardware specified in the Baseplate Installation Instructions.

Attachment Tab Height: 13.5"

Attachment Tab Width: 20"

Bolt Torque Specifications

Torque in Foot-Pounds for Metric Bolts

Bolt Size	Grade 8.8	Grade 10.9
6MM	6	8
8MM	16	22
10MM	31	40
12MM	54	70
14MM	89	117

Confirm the

and pre-towing procedures for your vehicle with the owner's manual or contact the vehicle's manufacturer for specific towing procedures.

Bolt Torque Specifications

Torque in Foot-Pounds for Inch Bolts

Bolt Size	Grade 5	Grade 8
1/4"	10	14
5/16"	19	29
3/8"	33	47
7/16"	54	78
1/2"	78	119
5/8"	154	230

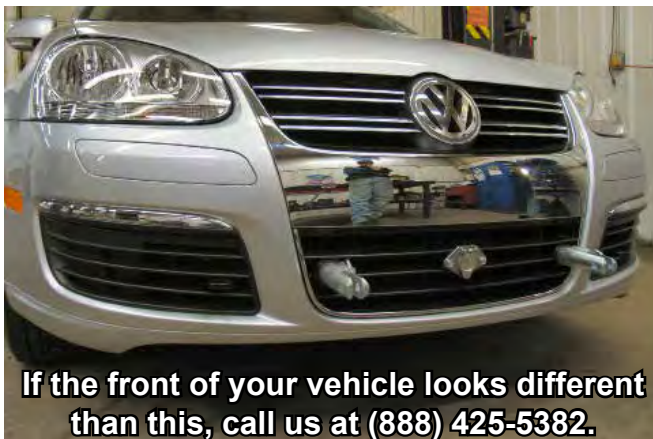

If the front of your vehicle looks different than this, call us at (888) 425-5382.

! WARNING

Failure to read and follow these instructions could result in separation of the towed vehicle from the tow bar, causing property damage, loss of towed vehicle, personal injury or death.

BX3823

2005-10 VW Jetta New

Installation Instructions

Parts List

Ref. No.	Qty.	Part #	Description
1	1	61-6146	Weldment, Baseplate, BX3823
2	8	61-5208	Weldment, 3/8-16 Nutplate, w/ 14" Wire
3	8	201-0440	3/8-16 X 1 1/2 Hex Bolt, Grd.5, ZP
4	8	203-0010	3/8 Lock Washer, ZP
5	1	201-0702	6MM-1.00 X 45MM Hex Bolt, Grd 8.8,
6	1	203-0161	6MM, Lock Washer, ZP
7	7	203-0002	5/16 Flat Washer, ZP
8	1	106-0366	Pipe, 1/4 Sch 40 X 3/4 Inch
9	2	201-0979	#12-14 x 1" Self Drilling Screw, ZP
10	2	201-0192	#10-32 x 1/2" Slot Rd. Hd. Screw
11	2	203-0054	#10 Lock Washer
12	2	202-0047	#10-32 Hex Nut
13	2	101-5822	Adapter, 4 Way Connector
14	2	62-3468	Attachment. Assembly, SF/SB (R)
	2	226-0046	Baseplate Safety Cable, 36" CL III (Not Shown)
	2	229-0359	Quicklink, 3/8, ZP (Not Shown)
	2	290-0437	Cap Plug, Black (Not Shown)

Tools Required

10MM Socket	Utility Knife
14MM Socket	Hammer
16MM Socket	Vise Grip
T25 Torx Socket	13/32" Drill Bit
T30 Torx Socket	1 1/4" Hole Saw
9/16" Socket	Tape Measure
Phillips Screwdriver	Loctite

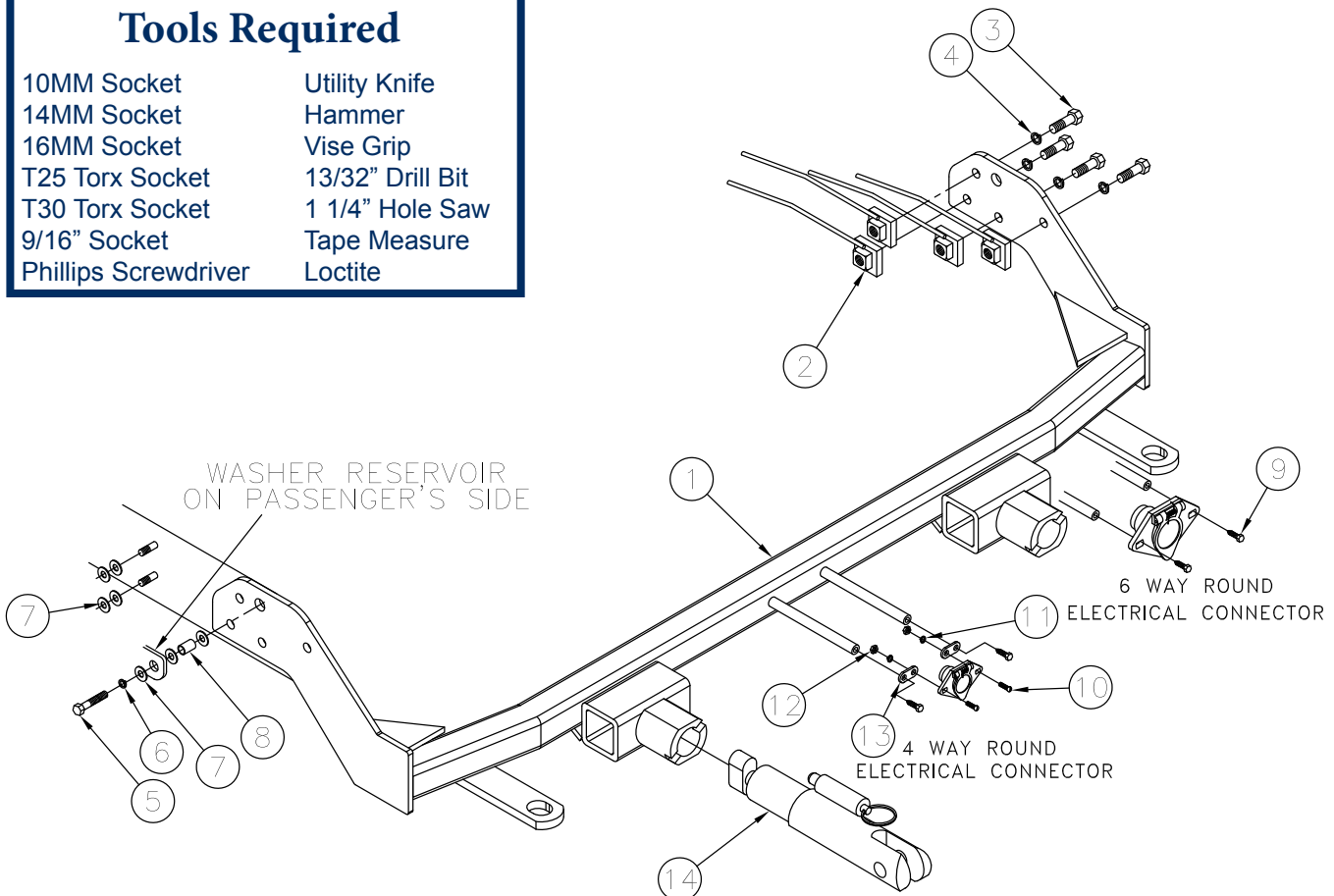

Important:

Use only genuine factory replacement parts on your baseplate. Do **NOT** substitute homemade or non-typical parts. If a bolt is lost or in need of replacement, for your safety and the preservation of your baseplate, be sure to use a replacement bolt of the same grade (In most cases it will be Grade 5, please reference the parts list above). Replacement parts may be ordered through your nearest Blue Ox® Dealer or Distributor, or call our Customer Care Team at (402)385-3051. Failing to follow and/or altering these installation instructions in either installation or required equipment will void the manufacturer's warranty.

BX3823

2005-10 VW Jetta New

Installation Instructions

Attachment Tabs:

Motorhome mount tow bars are recommended for use with this baseplate. Due to the design of the removable tabs, the RangeFinder II, Adventurer and Ambassador tow bars can not be used. The Acclaim tow bar may be used, but will not fold and store on the front of the vehicle. Adapters, except for the BX8833 and the BX88151, can not be used with this baseplate.

Instructions:

The upper grille, front fascia, metal bumper and windshield washer reservoir are removed and reinstalled. Trimming of metal bumper and webbing on frame end is required. Drilling is required.

The dimensional variations between otherwise identical vehicles can be considerable. While the baseplate was designed for easy installation, it may be necessary to tailor the baseplate slightly to compensate for auto manufacturer's tolerances. These minor adjustments may include filing a hole slightly, bending electrical rods or bending end plates.

The BX8869 Bulb & Socket Wiring Kit is recommended for this vehicle.



Installation Instructions:



1. Using the 25 Torx socket, remove the metric bolt just inside of the headlight assemblies. Do this on both sides of the vehicle. Set bolts aside to be reinstalled later.



2. Remove the two phillips screws from the lower grille, one on each side. Set screws aside to be reinstalled later.

BX3823

2005-10 VW Jetta New

Installation Instructions

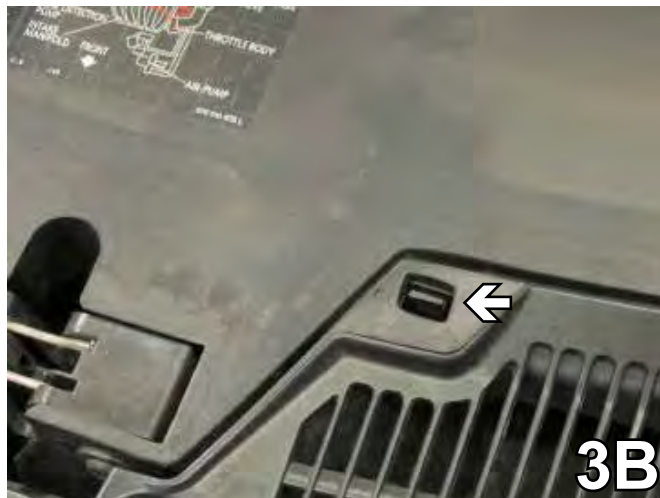

3. Using the flat screw driver, pry up the front edge of the grille, just inside the headlight assembly, to release the corner (3A). Pull the two clips forward to release the upper grille portion while pulling the upper grille forward and set aside to be reinstalled later (3B driver's side clip).

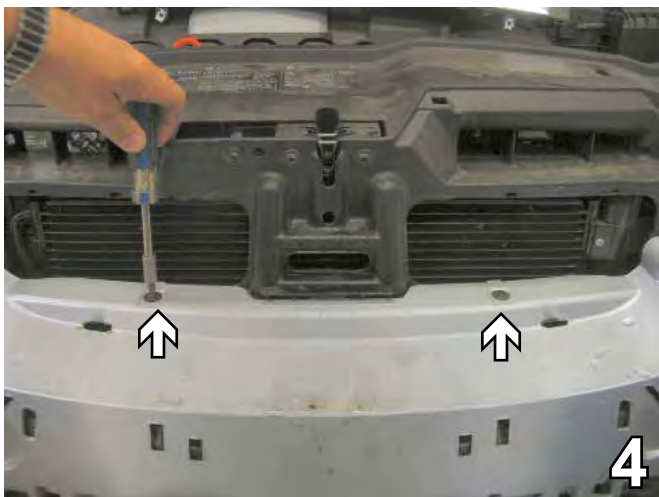

4. Below the grille, on the top of the metal bumper, are two Torx bolts to remove with the 30 Torx socket. Set bolts aside to be reinstalled later.
5. Remove three metric bolts just forward of the front tire on the edge of the wheel well, using the 25 Torx socket. Do this on both sides of the vehicle. Set bolts aside to be reinstalled later.

6. Remove the metric bolt from the corner of the fascia above the front tire, with the 25 Torx socket. Do this on both sides of the vehicle. Set bolts aside to be reinstalled later.



BX3823
2005-10 VW Jetta New
Installation Instructions

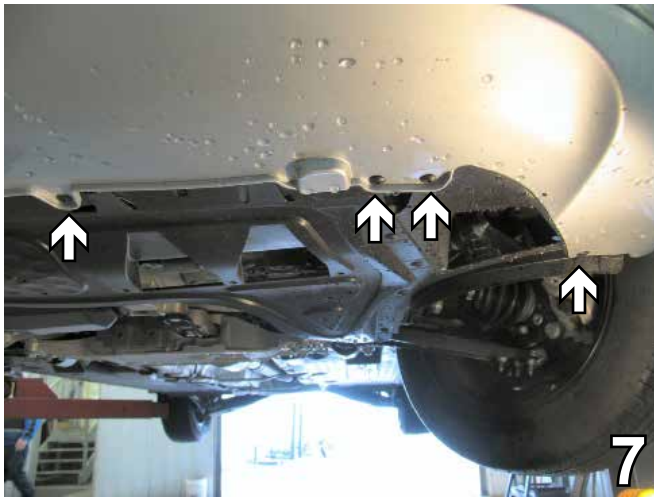

7. Use the 25 Torx socket, remove the four metric bolts from the lower edge of the fascia. Do this on both sides of the vehicle. Set bolts aside to be reinstalled later.



8. Remove the two Torx bolts just above the middle of the metal bumper with the 30 Torx socket.

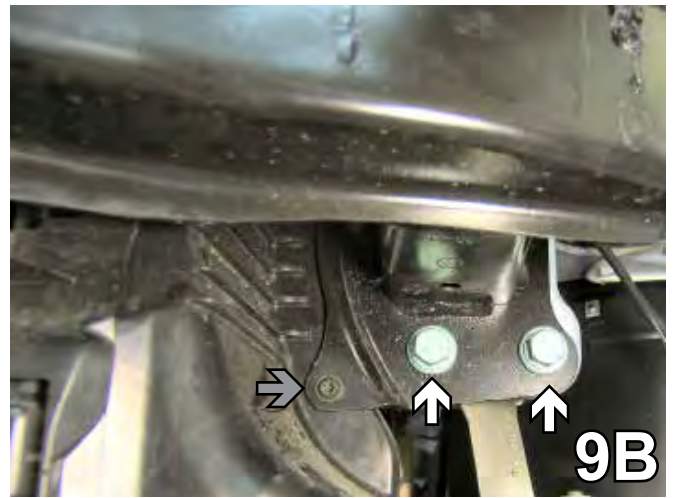
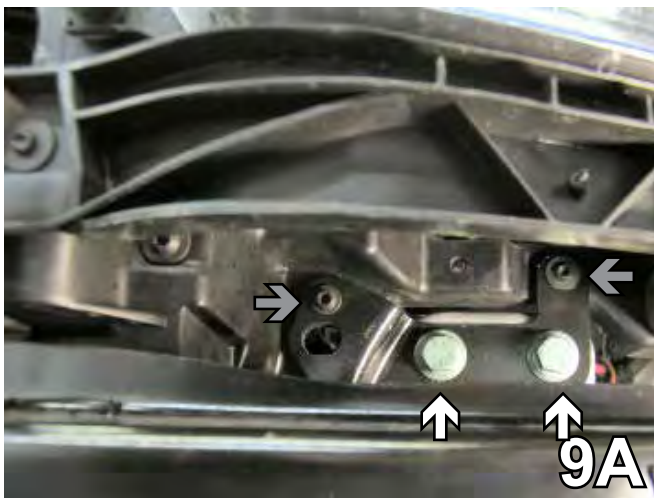

9. Before removing the metal bumper, mark the height of the bumper and the location of the bolts. Above the metal bumper (9A), using the 16MM socket remove the two metric hex bolts (white arrows). Using the 30 Torx socket, remove the two Torx bolts (gray arrows). Below the metal bumper (9B), using the 16MM socket remove the two metric hex bolts (white arrows). Using the 30 Torx socket, remove the Torx bolt (gray arrow). Do this on both sides of the vehicle. Pull the bumper forward and set it and the bolts aside to reinstall later.

BX3823

2005-10 VW Jetta New

Installation Instructions

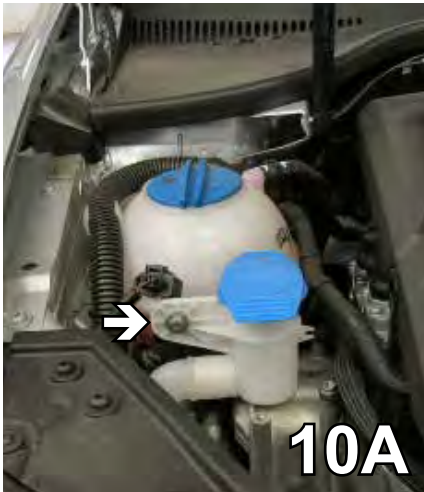

10. On the passenger's side, using the 10MM socket, remove the metric bolt from the washer reservoir spout (10A). Remove the two metric hex nuts between the wheel well and the reservoir (10B). Using the 10MM socket, remove the front metric bolt from the reservoir (10C). Disconnect all the electrical and fluid lines, plug the reservoir port. Pull the bottom of the reservoir away from the frame to clear the back studs, then pull the reservoir down. Set the reservoir, bolts and nuts aside to reinstall later.



11. Measure from the top edge of the frame end down and mark 2" and 5 1/2" on the side of the frame webbing. Using the reciprocating saw, cut the webbing to the side of the frame rail and make a vertical cut flush with the side of the frame between the first two cuts. Remove this area on both sides of the vehicle to prepare for the base plate installation. **Using a good quality spray paint, coat the cut edges to prevent corrosion.** Do this on both sides of the vehicle.

12. Measure and mark 3" up from the bottom edge of the air dam just below the metal bumper. Using a utility knife, cut and remove the upper portion. Do this on both sides of the vehicle.



BX3823
2005-10 VW Jetta New
Installation Instructions

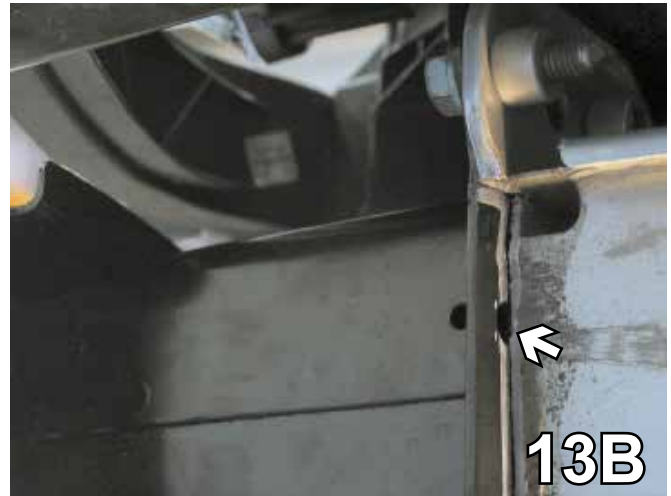

13. Reinstall the metal bumper using one metric hex bolt. Do this on both sides. (Adjust the height of the metal bumper to its original position). Mark the back side of the webbing where the frame webbing was removed. Remove the bumper, cut with the reciprocating saw and remove this area. Do this on both sides. **Using a good quality spray paint, coat the cut edges to prevent corrosion.**

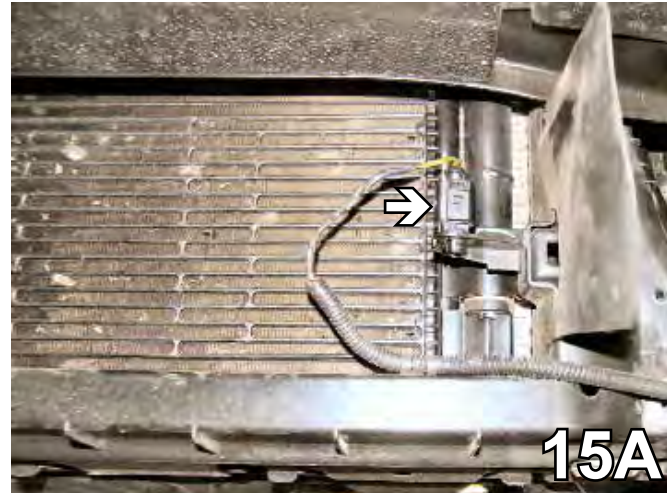
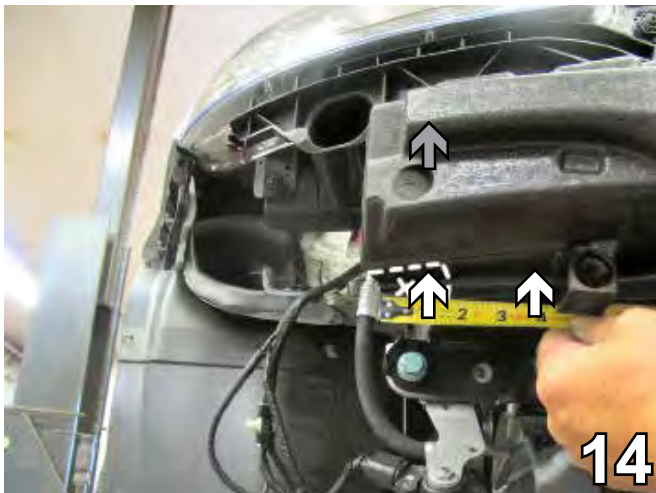

14. Reinstall the metal bumper to its original height, measure 1 3/4" from the end of the metal bumper and remove this lower area with the reciprocating saw. Do this on both sides.

15. Pull the temperature sensor up to release it from the top side of the bracket. Insert it into the bottom of the bracket and snap the sensor into place. This will prepare the area for the base plate installation.

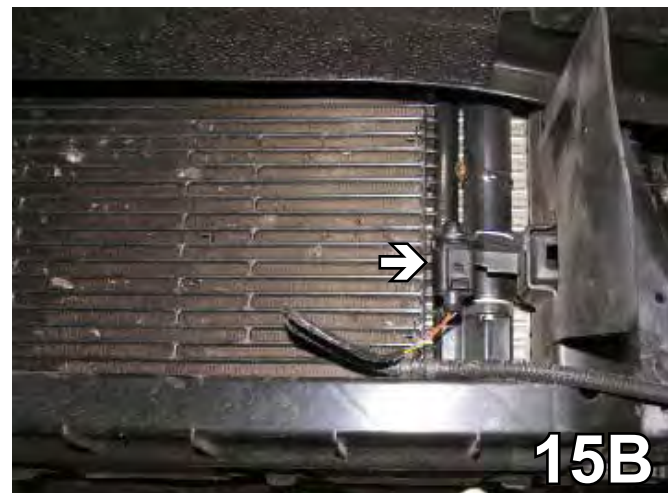

BX3823

2005-10 VW Jetta New

Installation Instructions



16. Using the 12MM socket, remove the metric bolt from the horn bracket. Unplug the electrical connections, set the horn and bracket aside. Do this on both sides of the vehicle.

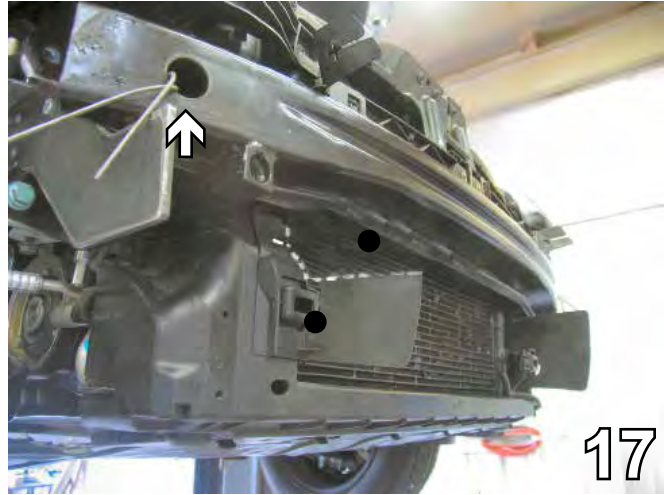

17. Using the 1 1/4" hole saw, cut a hole on the front of the metal bumper just forward of the center of the frame end. Do this on both sides of the vehicle. This will allow access to the inside of the frame end to insert the nut plates for the base plate installation.

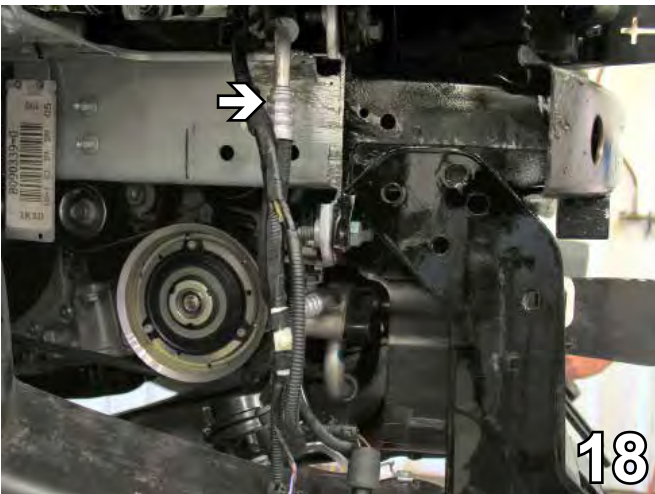

18. Slide the base plate onto the side of the frame with the attachment tabs down. Push the base plate back toward the rear of the vehicle while lifting the cross tube up. The bottom edge of the end plate should be even with the bottom edge of the frame. Align the top center hole with the existing bolt location for the front of the washer reservoir on the passenger's side, clamp to the frame with vise grips.

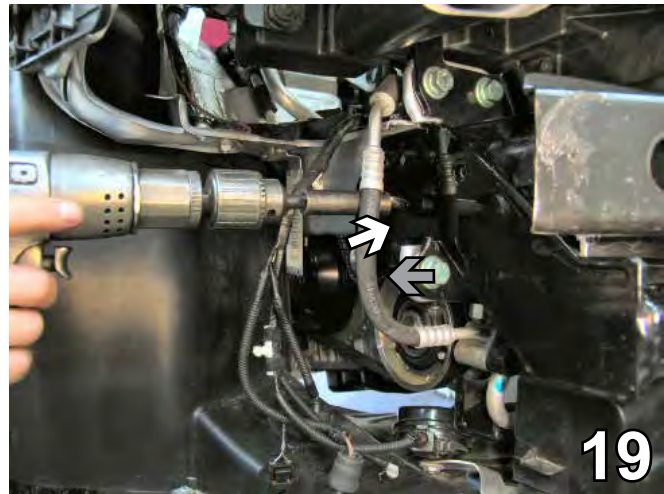

19. Using the baseplate as a template, drill the holes in the side of the frame rail with the 13/32" drill bit. Do this on both sides of the vehicle.

BX3823
2005-10 VW Jetta New
Installation Instructions



20. Insert the nut plate into the drilled hole on the front of the bumper to align with the drilled holes in the frame. Tighten the 3/8" bolts and lock washers on both sides. Keep the base plate attachment tabs level with the vehicle. **Be sure to use Loctite red on all the bolts before tightening. Tighten all the bolts according to Torque Chart in the General Instruction Sheet.**

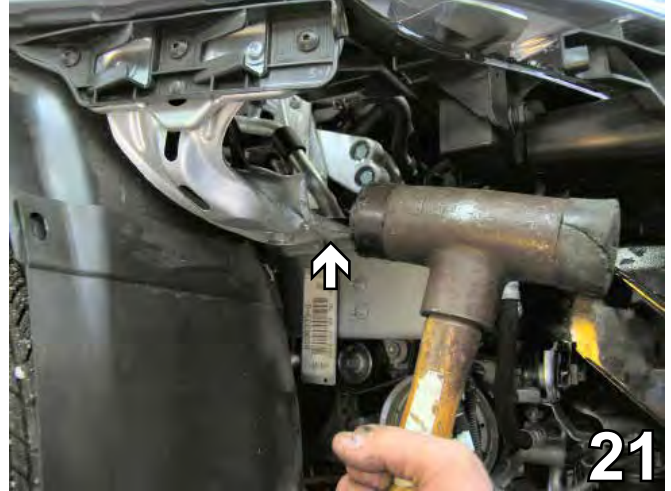

21. Using the hammer, tap the webbing toward the back of the vehicle 3/8", just behind the washer reservoir, on the passenger's side. This will prepare the area for reinstallation of the washer reservoir.

****BE SURE TO USE LOCTITE® RED ON ALL BOLTS BEFORE TIGHTENING. TIGHTEN ALL BOLTS ACCORDING TO THE TORQUE CHART ON PAGE 1 OF THESE INSTRUCTIONS OR ON PAGE 3 OF THE BASEPLATE TOWING GENERAL INSTRUCTIONS.**

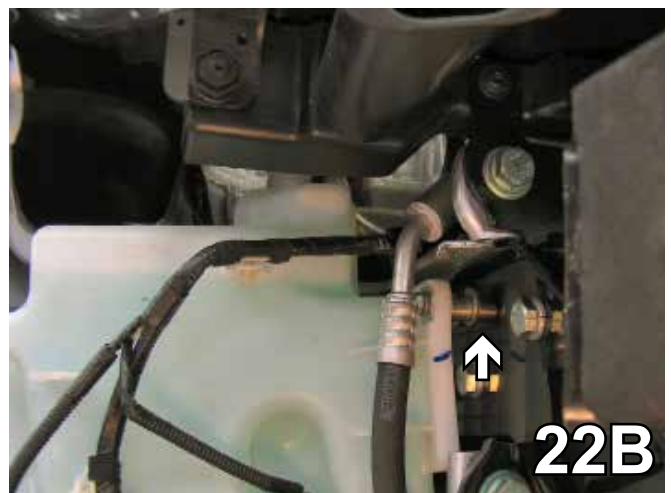
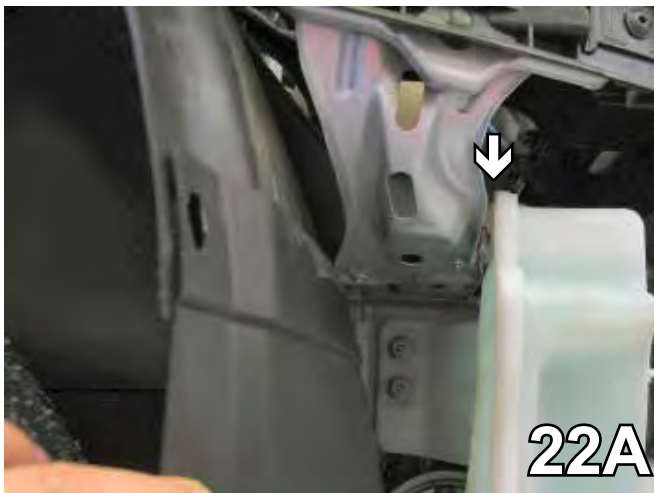

22. Put the washer reservoir in place on the back two studs (22A) and install the two hex nuts (Do not tighten). Replace the front metric bolt with the 6MM hex bolt provided. Install spacer tube, flat washers and lock washer provided (22B). **Be sure that the webbing does not touch on the back side of the reservoir. This will prevent webbing from rubbing a hole in the reservoir tank (22A).** Reconnect all the electrical and fluid lines to the reservoir (22B).

BX3823
2005-10 VW Jetta New
Installation Instructions



23. Reinstall both horns and their brackets. Reinstall the styrofoam on the front of the metal bumper.



24. Hold the fascia to its original position and carefully cut the lower grille with a utility knife or a hack saw blade, to allow attachment receivers to come through. Do this on both sides. Reinstall the fascia. The installation of the baseplate is complete.

Be sure that ALL electrical connections are plugged in properly and functioning BEFORE Installing the fascia.

25. The dimensional variations between otherwise identical cars can be considerable. While the baseplate was designed for easy installation, it may be necessary to tailor the baseplate slightly to compensate for auto manufacturers' tolerances. These minor adjustments may include filing a hole slightly, bending electrical rods, adding shims and/or bending endplates.

26. Install the tow bar and safety cables according to the instructions included in their packages. When demonstrating this to the customer. Be sure to include all the contents and packages.

27. Do **NOT** substitute other devices if the tow bar pins and clips are misplaced.

BX3823
2005-10 VW Jetta New
Installation Instructions

DEALER or INSTALLER:

Be certain the user receives the instruction sheets for their products.

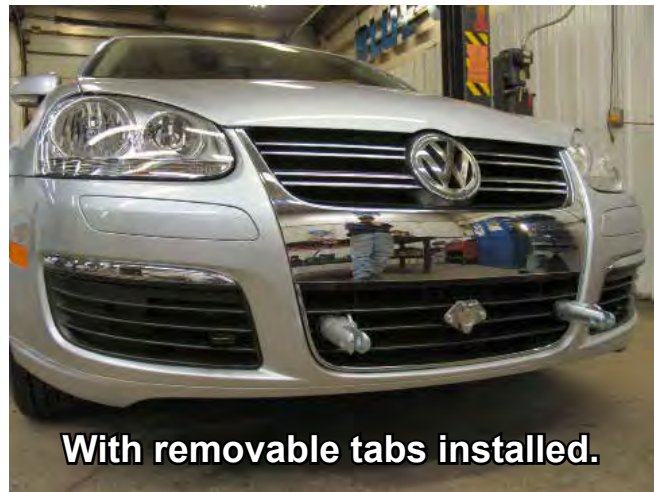

If the baseplate is in an accident, it must be replaced. DO NOT use it again! An accident can cause unseen damage and using it again could result in more damage or serious injury. DO NOT use the baseplate if it is damaged or missing parts.

CUSTOMER SERVICE COMMITMENT

Blue Ox is committed to providing you with exceptional customer care throughout your lifetime with our products. Our team is here to assist you with any questions you may have regarding the performance of your product. Simply call 1-800-228-9289 and you can speak with our customer care team.

Additionally, please visit our website to see which rallies our Destination America team will be attending. For a nominal fee, our service technician will service your towing system to ensure it's in proper working condition. Also as a commitment to our customers, should you visit our factory you can stay at our full service Blue Ox campground at no charge along with enjoying a factory tour.

Again thank you for being our customer and for the confidence you have shown in the performance of our products. It is because of customers like you we enjoy the success we have today.



© 2005, 08, 10 Blue Ox
One Mill Road, Industrial Park
Pender, Nebraska 68047
Phone: (402) 385-3051
Toll Free: (888) 425-5382
Fax: (402) 385-3360
www.blueox.us

General Information

1. Ensure that your product(s) are registered online at www.blueox.com. It is crucial to register your product(s) so that you may be alerted of product offerings, updates, upgrades, maintenance and safety bulletins, and/or recalls.
2. **It is the owner's responsibility to inspect all towing equipment for cracked welds, missing or worn parts and loose bolts before each towing trip.** Be sure to use Loctite® Red on all bolts and tighten to the recommended specifications.
3. **It is the owner's responsibility to hook up all towing equipment per manufacturer's instructions/recommendations.**
4. Remove the attachment tabs when not in use (if applicable).

Notice To Baseplate Installer

1. It is YOUR responsibility to watch for:

- Oil cooler and air conditioner lines
- Electrical wires and hoses
- Missing parts or attaching points on the frame

** If the baseplate is improperly installed and is against a wire or hose, it could cause fluid leaks or electrical shorts some time after the actual baseplate installation.

Permanent Baseplate Safety Cable Installation

Permanent baseplate safety cables are strongly recommended when towing a vehicle with a tow bar. The principle function of the permanent baseplate safety cables is to prevent the towed vehicle from breaking loose in the event the connection between the frame of the towed vehicle and the baseplate fails or becomes disconnected. The cables must be connected from the baseplate to the frame rail or cross member of the vehicle's frame. The illustrations below show the possible arrangements recommended by Blue Ox®. Each permanent baseplate safety cable must have an adequate weight rating for the towing system. The weight rating of the two (2) cables together will not qualify.

Do not mount the permanent baseplate safety cables against wires, hoses or brake lines.

These permanent baseplate safety cables should remain installed as long as the baseplate is installed on the vehicle. Permanent baseplate safety cables are to be used in conjunction with, and NOT a replacement for legally required safety cables attaching the towed vehicle to the towing vehicle.

OPTION #1

Permanent Baseplate Safety Cables to Cross Member or Frame of Towed Vehicle.

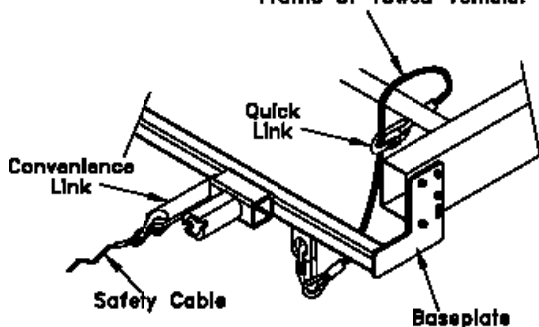

OPTION #2

Permanent Baseplate Safety Cables to Cross Member or Frame of Towed Vehicle.

