



BX1842

2008-13 Infiniti G37 Base/Sport 2014-16 Infiniti Q60S Installation Instructions

Attachment Tab Height: 15"

Attachment Tab Width: 25"

Serial Number

Please read BOTH these Installation Instructions and the General Information sheet prior to installing or operating this equipment.

1. Blue Ox® towing products and accessories are intended to be installed by Blue Ox® Dealers who are familiar with our products and have the equipment and knowledge necessary to do "fit work". If needed, Blue Ox® Dealers can be found at www.blueox.com or by contacting our Technical Service Department at (402) 385-3051.
2. Many Blue Ox® baseplates are designed to use existing holes and hardware to mount the baseplate to the towed vehicle. Even though bolts are there, do not assume they are adequate for baseplate mounting. Always use the hardware supplied in the hardware kit and existing hardware as specified in the installation instructions.



If the front of your vehicle looks different than this, please contact us at (402)385-3051.

Reference your vehicle owner's manual for manufacturer's towing specifications.

Bolt Torque Specifications

Torque in Foot-Pounds for Inch Bolts

Bolt Size	Grade 5	Grade 8
1/4"	10	14
5/16"	19	29
3/8"	33	47
7/16"	54	78
1/2"	78	119
5/8"	154	230
3/4"	257	380

Bolt Torque Specifications

Torque in Foot-Pounds for Metric Bolts

Bolt Size	Grade 8.8	Grade 10.9
6MM	6	8
8MM	16	22
10MM	31	40
12MM	54	70
14MM	89	117
16MM	161	230
18MM	222	318



WARNING

Failure to read and follow these instructions could result in separation of the towed vehicle from the tow bar, causing property damage, loss of towed vehicle, personal injury or death.

BX1842
2008-13 Infiniti G37 Base/Sport
2014-16 Infiniti Q60S
Installation Instructions

Tools Required

Lg Vise Grip
 Flat Screwdriver
 Utility Knife
 Torque Wrench
 Drill
 Tape Measure
 Loctite® RED
 13/32" Drill Bit
 1-1/4" Hole Saw
 10MM Socket
 12MM Socket
 9/16" Socket

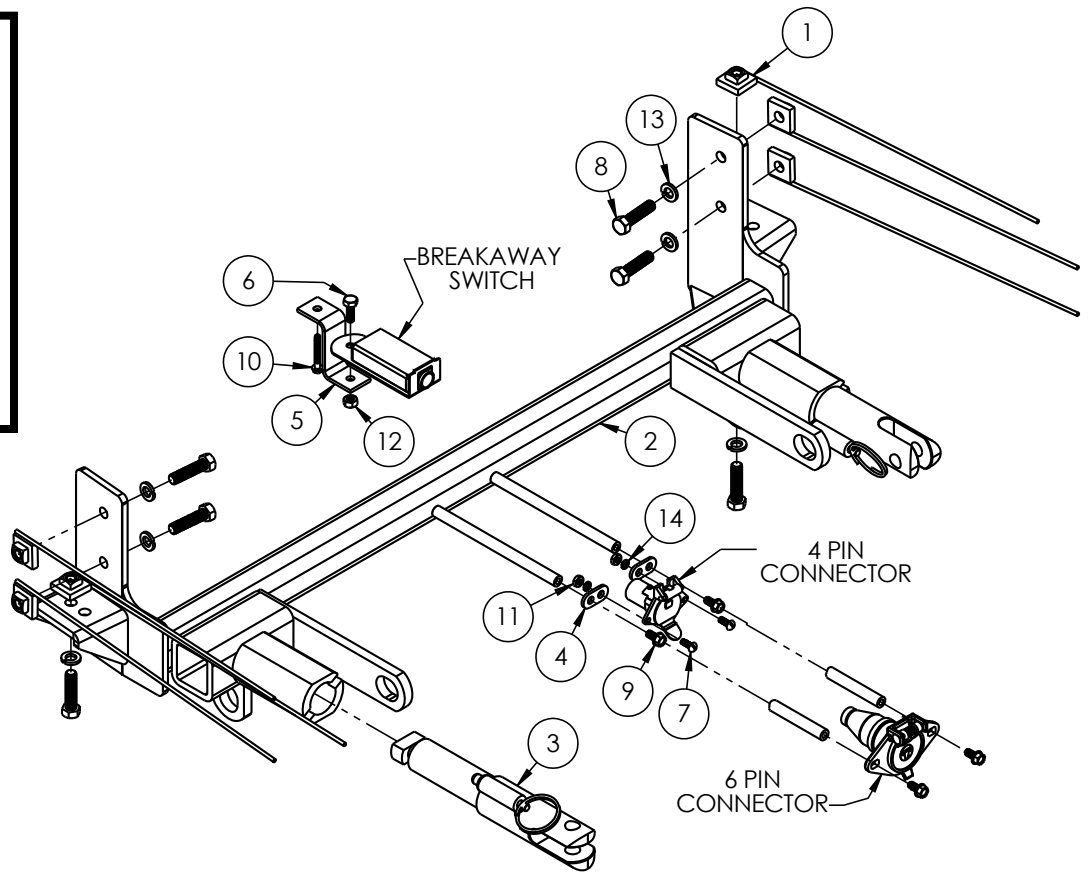

Ref. No.	Qty.	Part #	Description
1	6	61-5208	3/8"-16 Nut Plate with 14" Wire
2	1	61-6501	BX1842 Baseplate
3	2	62-3469	Attachment Tab
4	2	101-5822	4 Way Connector Adapter
5	1	102-7056	Breakaway Bracket
6	1	201-0050	1/4"-20 x 3/4" Hex Head Bolt, Grade 5, ZP
7	2	201-0192	#10-32 1/2" Slotted Round Head Screw
8	6	201-0440	3/8"-16 x 1-1/2" Hex Head Bolt, Grade 5, ZP
9	2	201-0979	#12-14 x 1" Self Drilling Screw, ZP
10	1	201-0654	#10-16 x 1" Self Tapping Screw, ZP
11	2	202-0047	#10-32 Hex Nut
12	1	202-0102	1/4"-20 Hex Nylon Nut, ZP
13	6	203-0010	3/8" Lock Washer, ZP
14	2	203-0054	#10 Lock Washer
15	2	226-0046 (not shown)	Class III Safety Cables
16	2	229-0359(not shown)	3/8" Quicklink, ZP
17	1	293-1339(not provided)	Breakaway Switch
18	1	294-0805 (not provided)	4 Pin Connector
19	1	294-0902 (not provided)	6 Pin Connector

Important:

Use only genuine factory replacement parts on your baseplate. Do **NOT** substitute homemade or non-typical parts. If a bolt is lost or in need of replacement, for your safety and the preservation of your baseplate, be sure to use a replacement bolt of the same grade (In most cases it will be Grade 5, please reference the parts list above). Replacement parts may be ordered through your nearest Blue Ox® Dealer or Distributor.

BX1842
2008-13 Infiniti G37 Base/Sport
2014-16 Infiniti Q60S
Installation Instructions

Instruction Notes: The fascia and bumper are removed and reinstalled for the baseplate installation. Some drilling and trimming is required.

Place all components that are removed on a flat, sturdy surface. All items will be reinstalled unless otherwise noted after the baseplate is installed.

The dimensional variations between otherwise identical vehicles can be considerable. While the baseplate was designed for easy installation, it may be necessary to tailor the baseplate slightly to compensate for vehicle manufacturer's tolerances.

The BX8848 4-Diode Wiring Kit is recommended for this vehicle.

NOTICE

- Handling of some cosmetic parts when installing this product may require the use of protective covers, rags, specialty tools, etc. to prevent damage.
- When using power drills be aware of the dangers of torque and drill bit length.
- When using a reciprocating saw be aware of objects behind the cutting surface.
- Use a good quality paint to spray cut edges of frame to prevent rusting.
- Be sure that **ALL** electrical connections are plugged in and accessories are functioning properly before reinstalling the fascia.
- The baseplate is computer tested to your vehicle's GVWR, exceeding this weight will void the manufacturer's warranty.
- Be sure to use a sufficient amount of Loctite® Red on all bolt threads before tightening. Tighten all bolts according to the torque chart provided.
- Dealer or installer be certain the user receives these instruction sheets.
- If the baseplate is in an accident, it must be replaced. **DO NOT** use it again! An accident can cause unseen damage and using it again could result in more damage or serious injury. **DO NOT** use the baseplate if it is damaged or missing parts.

BX1842
2008-13 Infiniti G37 Base/Sport
2014-16 Infiniti Q60S
Installation Instructions

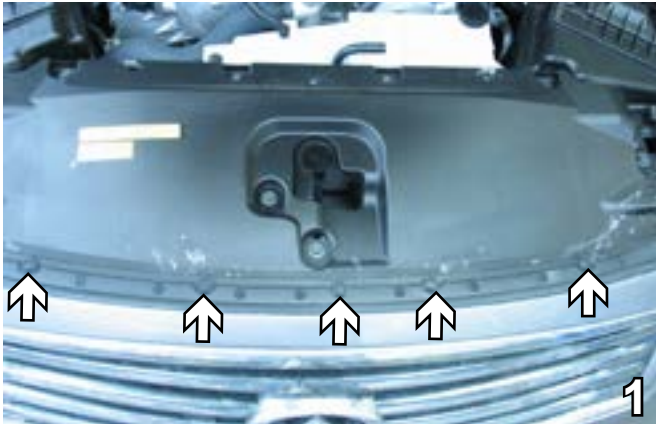

1. Using a flat screwdriver, remove seven (7) push pins from the flat plastic piece on top of fascia. Set push pins aside to be reinstalled later.



2. Pull back cover on the top above the front tire. Use a 10MM socket to remove the bolt. Do this to both sides of the vehicle. Set bolt aside to be reinstalled later.



3. Underneath the fascia remove the ten (10) bolts all the way across the bottom (driver's side shown) using a 10MM socket. Set bolts aside for later reinstallation.



4. Using a 10MM socket remove three (3) more bolts underneath the fascia in front of the tire. Do this on both sides. Set both aside for later reinstallation.



5. In the wheel well, just forward the front tire, remove one (1) push pin. Do this on both sides and set aside for later reinstallation.

BX1842
2008-13 Infiniti G37 Base/Sport
2014-16 Infiniti Q60S
Installation Instructions



6. Pry out the wheel well cover. Use a 10MM socket to remove bolt forward of the front tire. Do this to both sides of the vehicle. Set bolt aside to be reinstalled later. Pull the fascia corners out to the side of the vehicle, both sides, then pull fascia forward and carefully set aside for later reinstallation.

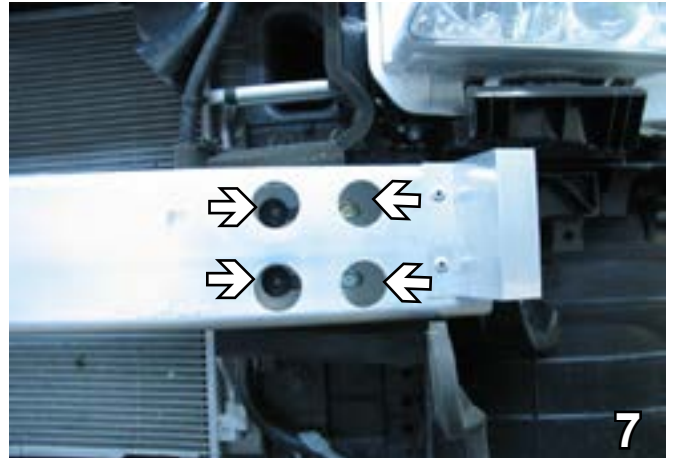

7. To remove the aluminum bumper, remove four (4) bolts, two (2) on the top and two (2) on the bottom using a 12MM socket. Do this to both sides. Unfasten all clips. Pull bumper forward. Set aside bumper and bolts for later reinstallation.

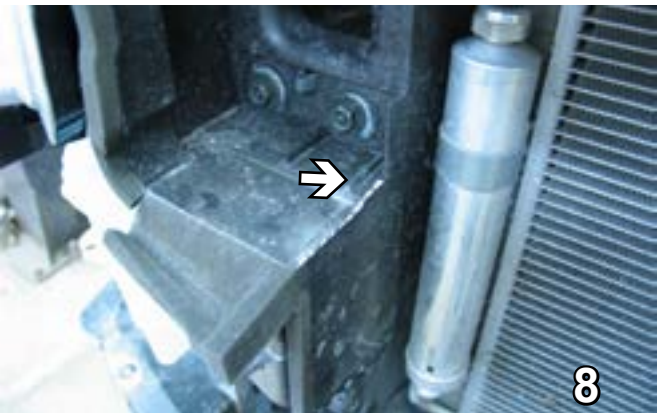

8. On the driver's side, unsnap the plastic cover. On the passenger side, use the utility knife to cut across the top and remove the plastic cover.

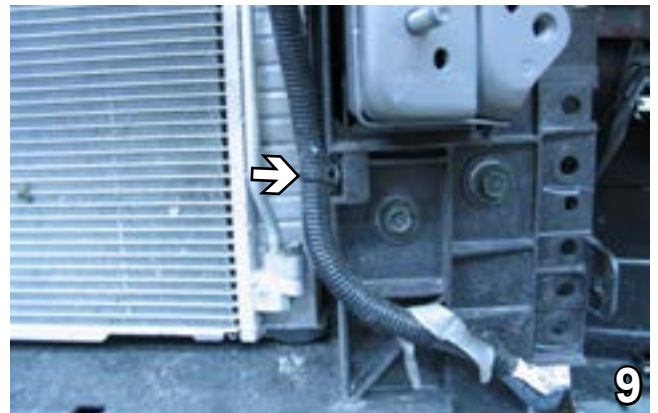

9. On the driver's side, pull the clip holding the hose to loosen it.

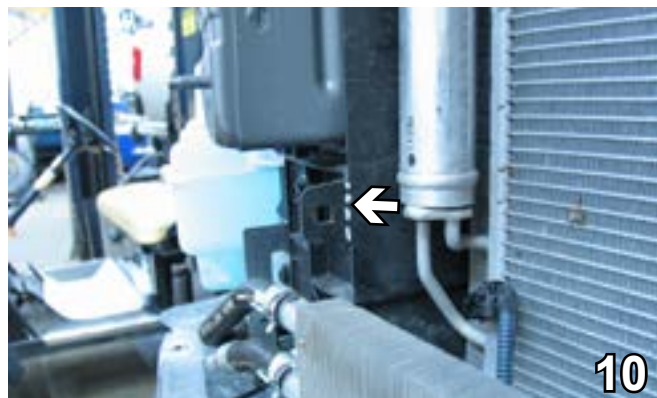

10. On the passenger side, with a utility knife trim off the plastic tab.

BX1842
2008-13 Infiniti G37 Base/Sport
2014-16 Infiniti Q60S
Installation Instructions

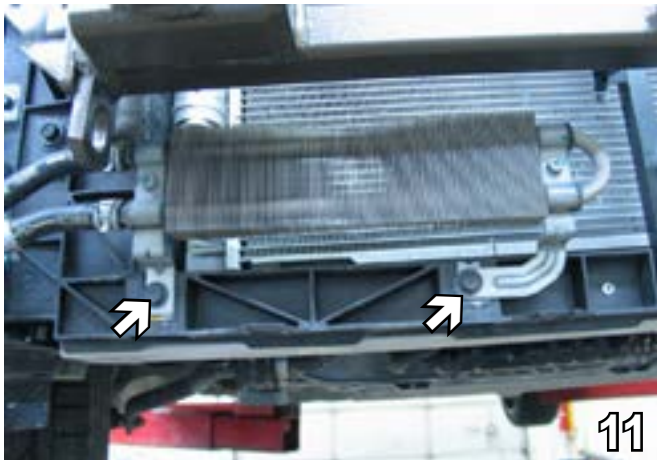

11. On the passenger side, using a 10MM socket remove the two bolts on the bottom of the radiator in order to swing it down and get it out of the way.

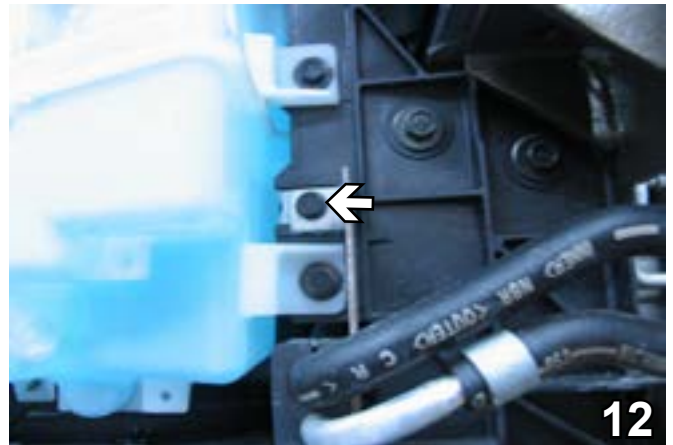

12. On the passenger side, using a 10MM socket remove the center bolt holding the washer reservoir.

Note: On convertible models the dampener on the passenger side will need to be removed and not reinstalled for baseplate installation.

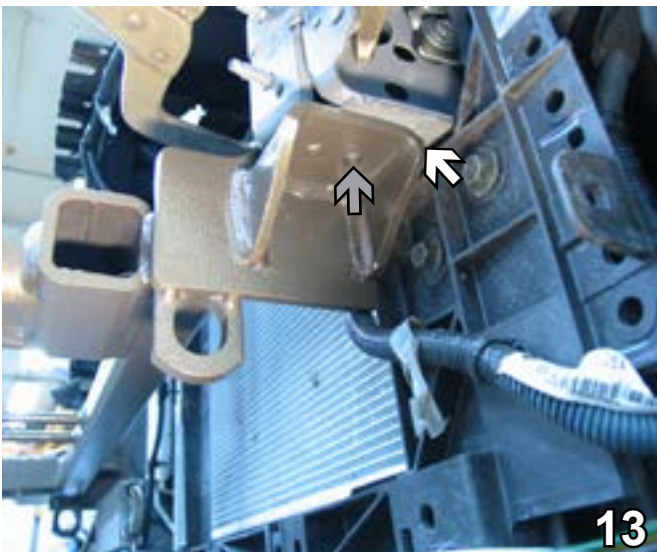

13. To install the baseplate raise up as high as possible until it hits the bottom of the bracket and as far back as it will go. Be sure it is level and clamp. Do this on both sides.

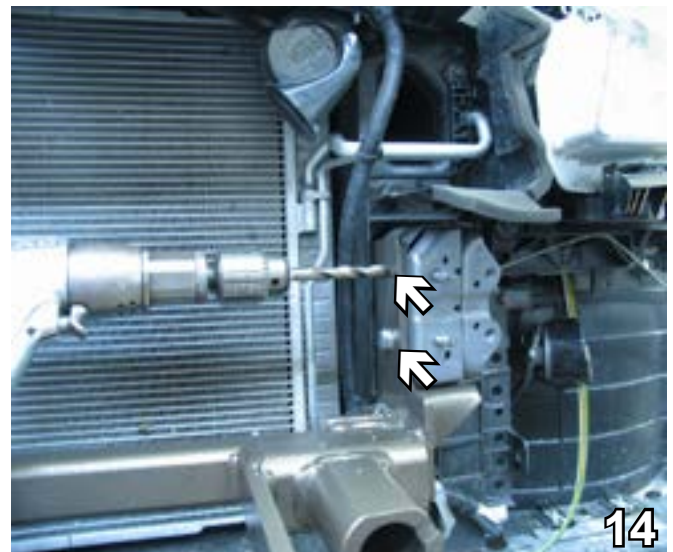

14. Using the baseplate as a template drill two holes into the side of the frame with the 13/32" drill bit. Do this on both sides.

BX1842
2008-13 Infiniti G37 Base/Sport
2014-16 Infiniti Q60S
Installation Instructions

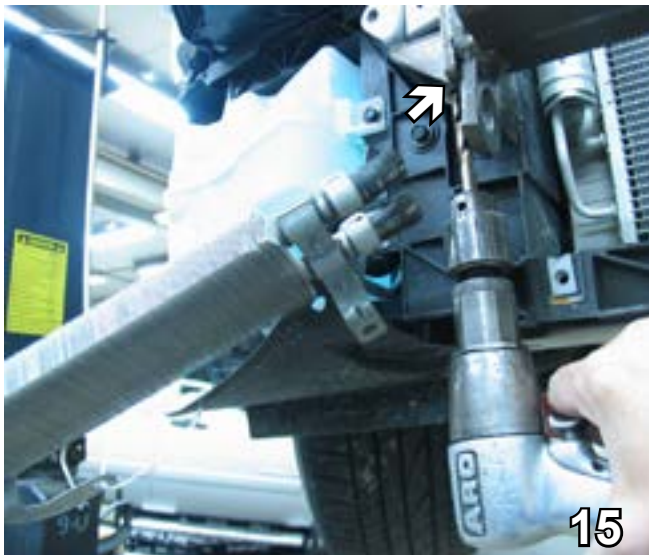

15. Also using the 13/32" drill bit, drill the back hole on the bottom of the plate (see gray arrow on #13). Do this on both sides.

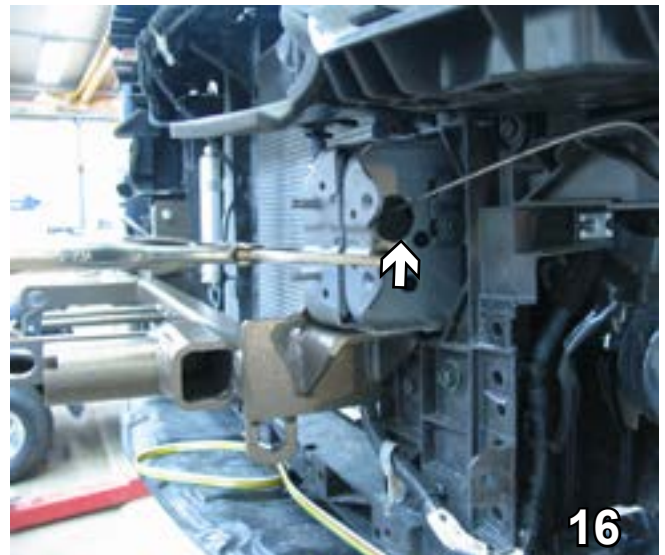

16. Use the 1 1/4" hole saw to drill the hole on the back side in order to insert the 61-5208s. Do this on both sides.

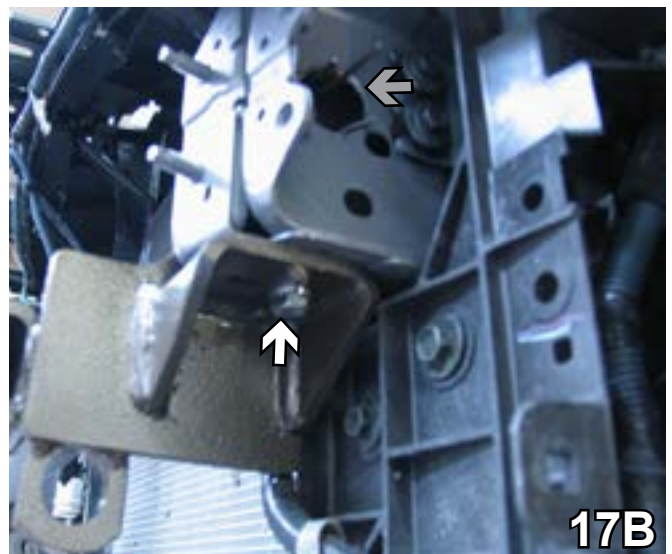
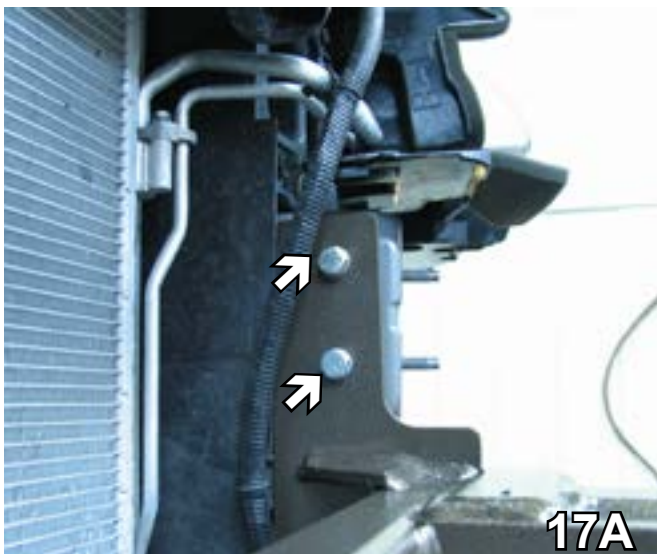

17. Install into the three drilled holes, two on the side and one on the bottom, 3/8-16 x 1 1/2" hex bolts and 3/8" lock washers with 61-5208 nut plates inserted into the frame end (photo 17B, gray arrow). Use Loctite Red on all the bolts and tighten. Do to both sides of the vehicle.

BX1842
2008-13 Infiniti G37 Base/Sport
2014-16 Infiniti Q60S
Installation Instructions

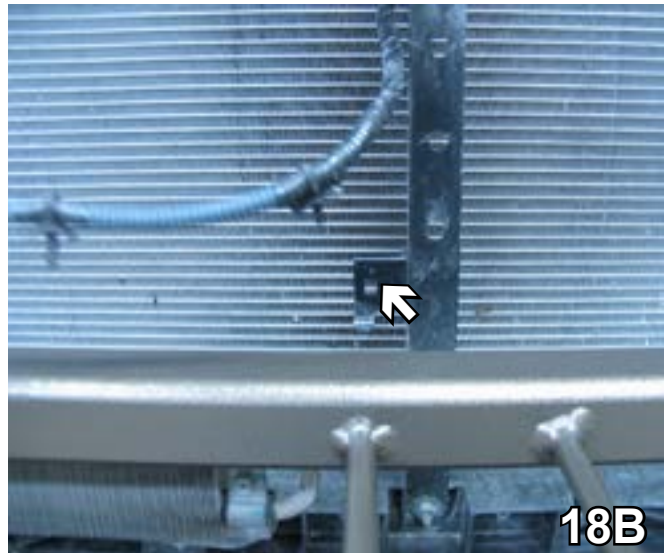

18. Pop off the plastic piece from the back of the bumper (photo 18A). Mount it to the bracket shown in photo 18B.



19. Attach the permanent baseplate safety cables to the provided convenience link on the baseplate. The photo above shows the recommended installation of the cables to frame of vehicle. Additional options may interfere with suggested mounting; in this case, secure the cables to a solid piece of the frame as described in the instructions included with the permanent baseplate safety cables. Be sure the safety cables do not rub against any hoses or moving parts. Do this on **BOTH** sides of the vehicle.

20. Reattach the radiator and reinstall the bumper.

21. Reinstall the fascia.

BX1842
2008-13 Infiniti G37 Base/Sport
2014-16 Infiniti Q60S
Installation Instructions



CUSTOMER SERVICE COMMITMENT

Blue Ox® is committed to providing you with exceptional customer care throughout your lifetime with our products. Our team is here to assist you with any questions you may have regarding the performance of your product. Simply call (402) 385-3051 and you can speak with our technical service team.

Additionally, please visit our website to see which rallies our Destination America team will be attending. For a nominal fee, our service technician will service your towing system to ensure it's in proper working condition. Also, as a commitment to our customers, should you visit our factory, you can stay at our full service Blue Ox® campground at no charge along with enjoying a factory tour.

Again, thank you for being our customer and for the confidence you have shown in the performance of our products. It is because of customers like you we enjoy the success we have today.

© 2015 Blue Ox
One Mill Road, Industrial Park
Pender, Nebraska 68047
Phone: (402) 385-3051
Fax: (402) 385-3360
www.blueox.com

General Information

1. Ensure that your product(s) are registered online at www.blueox.com. It is crucial to register your product(s) so that you may be alerted of product offerings, updates, upgrades, maintenance and safety bulletins, and/or recalls.
2. **It is the owner's responsibility to inspect all towing equipment for cracked welds, missing or worn parts and loose bolts before each towing trip.** Be sure to use Loctite® Red on all bolts and tighten to the recommended specifications.
3. **It is the owner's responsibility to hook up all towing equipment per manufacturer's instructions/recommendations.**
4. Remove the attachment tabs when not in use (if applicable).

Notice To Baseplate Installer

1. It is YOUR responsibility to watch for:

- Oil cooler and air conditioner lines
- Electrical wires and hoses
- Missing parts or attaching points on the frame

** If the baseplate is improperly installed and is against a wire or hose, it could cause fluid leaks or electrical shorts some time after the actual baseplate installation.

Permanent Baseplate Safety Cable Installation

Permanent baseplate safety cables are strongly recommended when towing a vehicle with a tow bar. The principle function of the permanent baseplate safety cables is to prevent the towed vehicle from breaking loose in the event the connection between the frame of the towed vehicle and the baseplate fails or becomes disconnected. The cables must be connected from the baseplate to the frame rail or cross member of the vehicle's frame. The illustrations below show the possible arrangements recommended by Blue Ox®. Each permanent baseplate safety cable must have an adequate weight rating for the towing system. The weight rating of the two (2) cables together will not qualify.

Do not mount the permanent baseplate safety cables against wires, hoses or brake lines.

These permanent baseplate safety cables should remain installed as long as the baseplate is installed on the vehicle. Permanent baseplate safety cables are to be used in conjunction with, and NOT a replacement for legally required safety cables attaching the towed vehicle to the towing vehicle.

OPTION #1

Permanent Baseplate Safety Cables to Cross Member or Frame of Towed Vehicle.

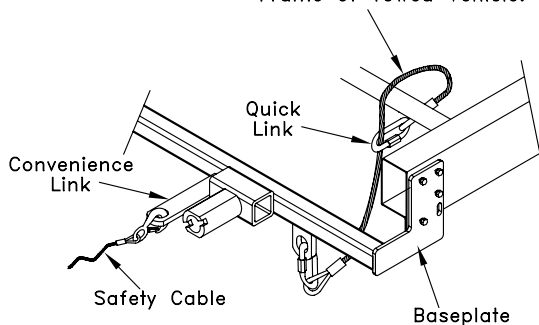

OPTION #2

Permanent Baseplate Safety Cables to Cross Member or Frame of Towed Vehicle.

