



BLUE OX®

BX1845

2010-12 Nissan Versa Hatchback S/
SL

Installation Instructions

Serial Number

Attachment Tab Height: 14"

Attachment Tab Width: 26"

Please read BOTH these Installation Instructions and the General Instructions prior to installing or operating this equipment.

- Blue Ox® towing products and accessories are intended to be installed by Blue Ox® Dealers who are familiar with our products and have the equipment and knowledge necessary to do "fit work". If needed, Blue Ox® Dealers can be found at www.blueox.com or by contacting our Customer Care Department at (402) 385-3051.
- Many Blue Ox® baseplates are designed to use existing holes and hardware to mount the baseplate to the towed vehicle. Even though bolts are there, do not assume they are adequate for baseplate mounting. Always use the hardware supplied in the hardware kit and existing hardware as specified in the installation instructions.

Bolt Torque Specifications
Torque in Foot-Pounds for Metric Bolts

Bolt Size	Grade 8.8	Grade 10.9
6MM	6	8
8MM	16	22
10MM	31	40
12MM	54	70
14MM	89	117

Bolt Torque Specifications
Torque in Foot-Pounds for Inch Bolts

Bolt Size	Grade 5	Grade 8
1/4"	10	14
5/16"	19	29
3/8"	33	47
7/16"	54	78
1/2"	78	119
5/8"	154	230



If the front of your vehicle looks different than this, please contact us at (402)385-3051.

Reference your vehicle owner's manual for manufacturer's towing specifications.

! WARNING

Failure to read and follow these instructions could result in separation of the towed vehicle from the tow bar, causing property damage, loss of towed vehicle, personal injury or death.

BX1845
2010-12 Nissan Versa Hatchback S/SL
Installation Instructions

Instruction Notes: The fascia, radiator cover, styrofoam reinforcement, headlights and windshield washer fluid reservoir are removed and reinstalled for the baseplate installation. Some drilling and trimming is required.

Place all components that are removed on a flat, sturdy surface. All items will be reinstalled unless otherwise noted after the baseplate is installed.

The dimensional variations between otherwise identical vehicles can be considerable. While the baseplate was designed for easy installation, it may be necessary to tailor the baseplate slightly to compensate for vehicle manufacturer's tolerances.

The BX8869 Tail Light Wiring Kit is recommended for this vehicle.

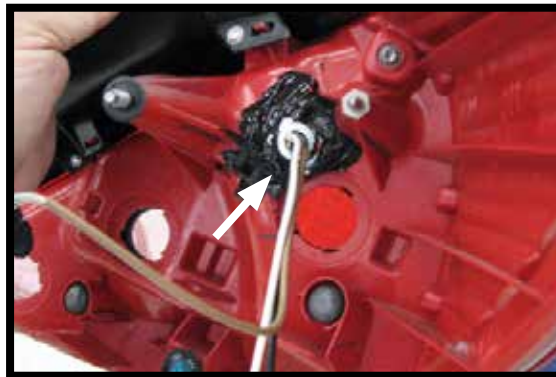

Drill a hole according to the tail
light wiring kit instructions.

NOTICE

- Handling of some cosmetic parts when installing this product may require the use of protective covers, rags, specialty tools, etc. to prevent damage.
- When using power drills be aware of the dangers of torque and drill bit length.
- When using a reciprocating saw be aware of objects behind the cutting surface.
- Use a good quality paint to spray cut edges of frame to prevent rusting.
- Be sure that **ALL** electrical connections are plugged in and accessories are functioning properly before reinstalling the fascia.
- Do not use the towed vehicle for storing luggage, equipment, etc. This may cause you to exceed the towing capacity of the tow bar, baseplate and its accessories.
- Be sure to use Loctite® Red on all bolts before tightening. Tighten all bolts according to the torque chart provided.
- Dealer or installer be certain the user receives these instruction sheet.
- If the baseplate is in an accident, it must be replaced. **DO NOT** use it again! An accident can cause unseen damage and using it again could result in more damage or serious injury. **DO NOT** use the baseplate if it is damaged or missing parts.

BX1845
2010-12 Nissan Versa Hatchback S/SL
Installation Instructions

Tools Required

Large Vise Grip
Utility Knife
Torque Wrench
Drill
Reciprocating Saw
Tape Measure
Loctite® RED
13/32" Drill Bit
10MM Socket
9/16" Socket
9/16" Wrench

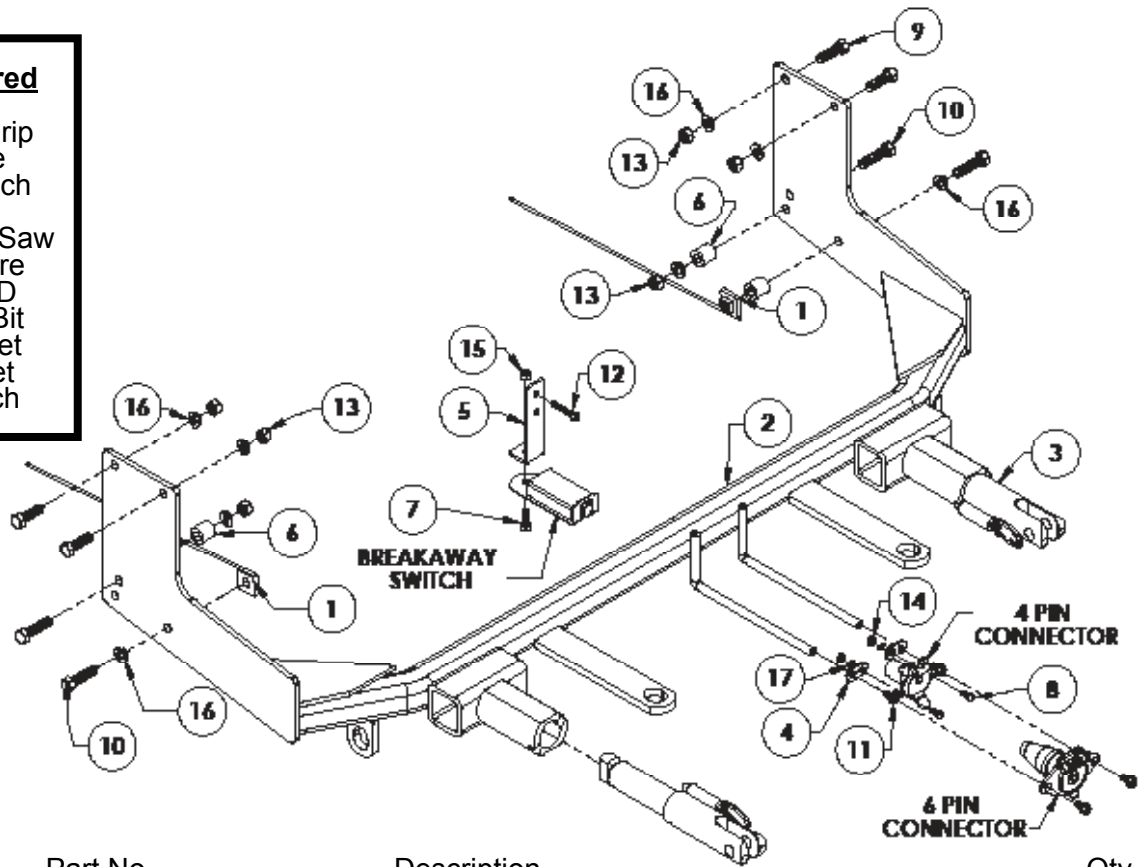

Item No.	Part No.	Description	Qty.
1	61-5208	3/8"-16 Nut Plate w/ 14" Wire	2
2	61-6734	BX1845 Baseplate	1
3	62-3469	Attachment Tab Assembly with Hole	2
4	101-5822	4 Way Connector Adapter	2
5	102-7186	Breakaway Bracket	1
6	107-1753	3/4" O.D. Spacer Tube x 3/4"L	3
7	201-0050	1/4"-20 x 3/4" Hex Head Bolt, Grade 5, ZP	1
8	201-0192	#10-32 1/2" Round Slotted Head Screw	2
9	201-0368	3/8"-16 x 1-1/4" Hex Head Bolt, Grade 5, ZP	4
10	201-0440	3/8"-16 x 1-1/2" Hex Head Bolt, Grade 5, ZP	4
11	201-0979	#12-14 x 1" Self Drilling Screw, ZP	2
12	201-0654	#10-16 x 1" Self Drilling Screw	1
13	202-0003	3/8"-16 Hex Nut, ZP	6
14	202-0047	#10-32 Hex Nut	2
15	202-0102	1/4"-20 Hex Nylon Nut, ZP	1
16	203-0010	3/8" Lock Washer, ZP	8
17	203-0054	#10 Lock Washer, ZP	2
18	226-0046(not shown)	Class III Safety Cables	2
19	229-0359(not shown)	3/8" Quicklink, ZP	2
20	290-0437(not shown)	Black Cap Plug Receiver	2

Important:

Use only genuine factory replacement parts on your baseplate. Do **NOT** substitute homemade or non-typical parts. If a bolt is lost or in need of replacement, for your safety and the preservation of your baseplate, be sure to use a replacement bolt of the same grade (In most cases it will be Grade 5, please reference the parts list above). Replacement parts may be ordered through your nearest Blue Ox® Dealer or Distributor. Failing to follow and/or altering these installation instructions in either installation or required equipment will void the manufacturer's warranty. Towing behind a non-motorized vehicle will void the warranty.

BX1845
2010-12 Nissan Versa Hatchback S/SL
Installation Instructions

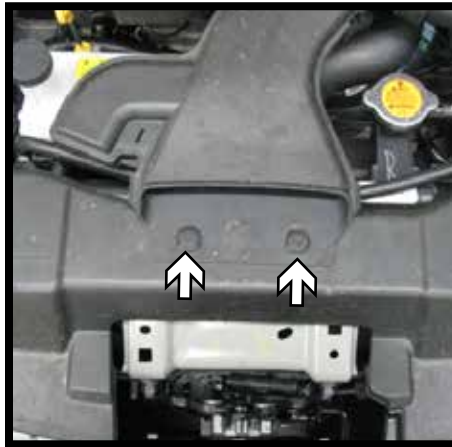

1. Remove the eleven (11) push pins from the top of the radiator cover and remove from the vehicle.



2. Remove the two (2) push pins from the top of the fascia. Do this on both sides of the vehicle.



3. Using a 10MM socket, remove the three (3) screws from the underside corner of the fascia. Do this on both sides of the vehicle.

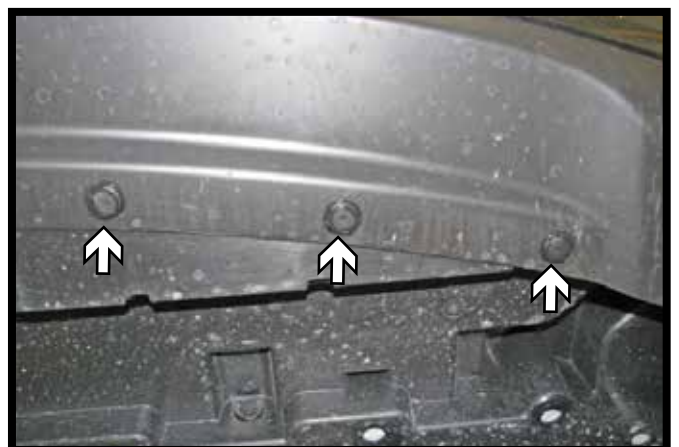

4. Remove the three (3) push pins from the underside front of the fascia. Do this on both sides of the vehicle.

BX1845
2010-12 Nissan Versa Hatchback S/SL
Installation Instructions



5. Pull the wheel well cover back, then using a 10MM socket, remove the screw from the inside top edge of the fascia. Do this on both sides of the vehicle. Remove the fascia from the vehicle.



6. Remove the styrofoam reinforcement and push pin (white) from the metal bumper. Using a utility knife trim the plastic shrouding as shown (gray). Do this on both sides of the vehicle.



7. On the passenger side, disconnect and/or cap the electrical connections and fluid lines from the washer reservoir. Using a 10MM socket remove the lower bolt.

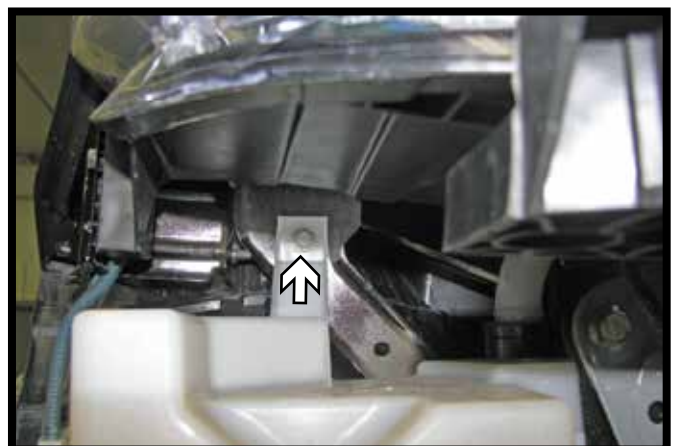

8. Using a 10MM socket, remove the upper bolt from the reservoir. Disconnect the filler tube and remove the reservoir from the vehicle.

BX1845
2010-12 Nissan Versa Hatchback S/SL
Installation Instructions

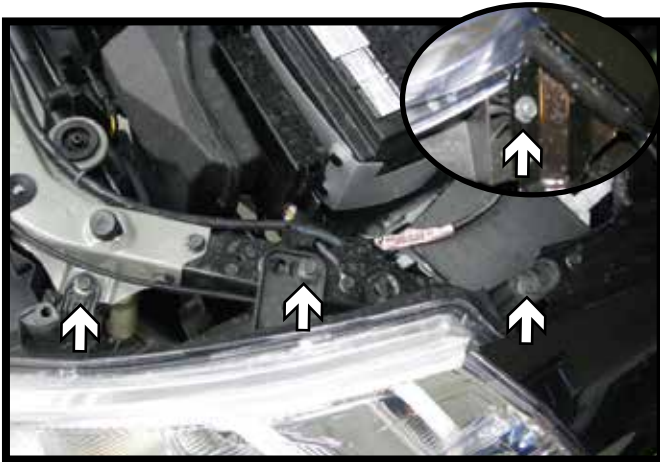

9. Using a 10MM socket, remove the three (3) screws from the top of the headlight and the one (1) on the side. Unhook the electrical connections and remove the headlight. Do this on both sides of the vehicle.

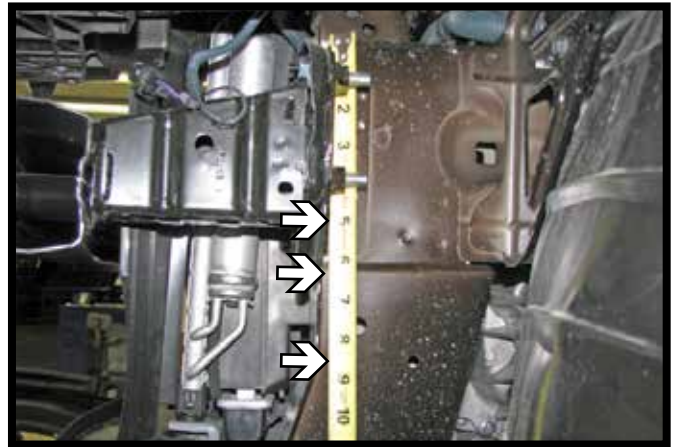

10. Mark the frame rail webbing at 5", 6-1/2" and 8-3/4" from the top of the frame rail. Using a reciprocating saw, cut the webbing to the frame rail (the top cut goes through bumper bracket also). Cut and remove the upper section of the webbing. Do this on both sides of the vehicle.

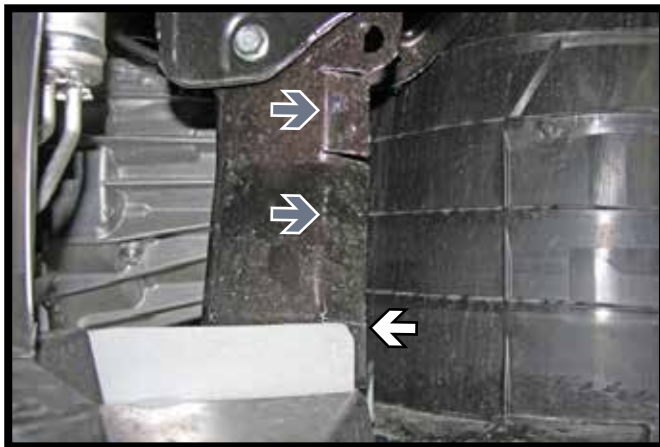

11. Using a reciprocating saw, cut the lower portion of webbing where it begins to angle down (white) to the webbing of the frame rail. Flatten the sections (above this cut, not below it) flush against the frame rail (gray) with a hammer. Do this to both sides of the vehicle.

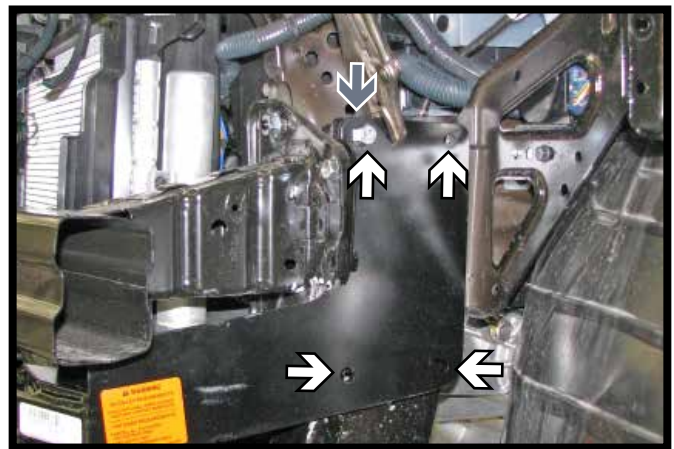

12. Align the top front edge of the baseplate with the top of the frame rail (gray) and pull the baseplate as far forward as possible. The top back edge of baseplate will dip slightly below the top of the frame rail. Level and clamp the baseplate into position. Using the baseplate as a template to drill four (4) 13/32" holes (white) into the frame rail. Do this to both sides of the vehicle.

BX1845
2010-12 Nissan Versa Hatchback S/SL
Installation Instructions



13. In the upper holes, install 3/8"-16 x 1-1/4" bolts with 3/8" lock washers, 3/8"-16 hex nuts (white). Insert one (1) 3/8"-16 nut plate through frame opening and align to lower front hole and install a 3/8"-16 x 1-1/2" bolt with 3/8" lock washer. On the driver side also include a 3/4" spacer (gray). Install 3/8"-16 x 1-1/2" bolt into the lower back hole (black) with a 3/4" spacer, 3/8" lock washer and 3/8"-16 nut. Tighten all bolts. Do this on both sides of the vehicle.



14. Attach the permanent baseplate safety cables to the provided convenience link on the baseplate. The photo beside shows the recommended installation of the cables to frame of vehicle. Additional options may interfere with suggested mounting; in this case, secure the cables to a solid piece of the frame as described in the instructions included with the permanent baseplate safety cables. Be sure the safety cables do not rub against any hoses or moving parts. Do this on **BOTH** sides of the vehicle.



15. Reinstall the washer reservoir and headlights.



16. On the backside of the fascia, trim the outside of the middle rib. From the outside edge go in 3/4" up 1/2" into the rib. Then over 3" tapering off flush. Do this on both ends of the fascia.

BX1845
2010-12 Nissan Versa Hatchback S/SL
Installation Instructions

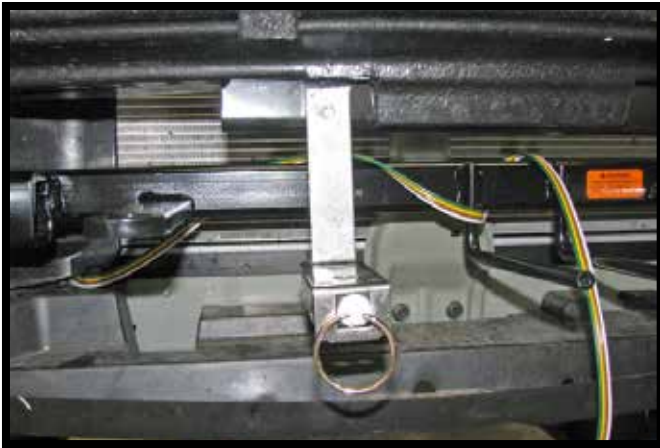

17. Install the breakaway bracket, using a #10-16 x 1" self drilling screw, to the tab on the underside of the bumper. Attach the breakaway to the bracket with 1/4"-20 x 3/4" bolt and 1/4" nut.

18. Reinstall the styrofoam reinforcement, fascia and radiator cover.

CUSTOMER SERVICE COMMITMENT

Blue Ox® is committed to providing you with exceptional customer care throughout your lifetime with our products. Our team is here to assist you with any questions you may have regarding the performance of your product. Simply call (402) 385-3051 and you can speak with our customer care team.

Additionally, please visit our website to see which rallies our Destination America team will be attending. For a nominal fee, our service technician will service your towing system to ensure it's in proper working condition. Also, as a commitment to our customers, should you visit our factory, you can stay at our full service Blue Ox® campground at no charge along with enjoying a factory tour.

Again, thank you for being our customer and for the confidence you have shown in the performance of our products. It is because of customers like you we enjoy the success we have today.

© 2012 Blue Ox
One Mill Road, Industrial Park
Pender, Nebraska 68047
Phone: (402) 385-3051
Fax: (402) 385-3360
www.blueox.com

General Information

1. Ensure that your product(s) are registered online at www.blueox.com. It is crucial to register your product(s) so that you may be alerted of product offerings, updates, upgrades, maintenance and safety bulletins, and/or recalls.
2. **It is the owner's responsibility to inspect all towing equipment for cracked welds, missing or worn parts and loose bolts before each towing trip.** Be sure to use Loctite® Red on all bolts and tighten to the recommended specifications.
3. **It is the owner's responsibility to hook up all towing equipment per manufacturer's instructions/recommendations.**
4. Remove the attachment tabs when not in use (if applicable).

Notice To Baseplate Installer

1. It is YOUR responsibility to watch for:

- Oil cooler and air conditioner lines
- Electrical wires and hoses
- Missing parts or attaching points on the frame

** If the baseplate is improperly installed and is against a wire or hose, it could cause fluid leaks or electrical shorts some time after the actual baseplate installation.

Permanent Baseplate Safety Cable Installation

Permanent baseplate safety cables are strongly recommended when towing a vehicle with a tow bar. The principle function of the permanent baseplate safety cables is to prevent the towed vehicle from breaking loose in the event the connection between the frame of the towed vehicle and the baseplate fails or becomes disconnected. The cables must be connected from the baseplate to the frame rail or cross member of the vehicle's frame. The illustrations below show the possible arrangements recommended by Blue Ox®. Each permanent baseplate safety cable must have an adequate weight rating for the towing system. The weight rating of the two (2) cables together will not qualify.

Do not mount the permanent baseplate safety cables against wires, hoses or brake lines.

These permanent baseplate safety cables should remain installed as long as the baseplate is installed on the vehicle. Permanent baseplate safety cables are to be used in conjunction with, and NOT a replacement for legally required safety cables attaching the towed vehicle to the towing vehicle.

OPTION #1

Permanent Baseplate Safety Cables to Cross Member or Frame of Towed Vehicle.



OPTION #2

Permanent Baseplate Safety Cables to Cross Member or Frame of Towed Vehicle.

