



Strong As An Ox™

BX1945 Installation Instructions 2001-03 Chrysler Sebring

Serial No.

The front fascia and metal bumper is removed for baseplate installation. Holes need to be drilled. The attachment tabs are center to center at 22 3/4 inches and at 14 inches height.



1. Remove the six push pins from the top of grill.



3. Remove the two metric bolts on the top side grill with 10MM socket. Pull fascia forward and set aside.



5. On the bottom of metal bumper is a temperature sensor and two push pins that need to be removed from coolant line. Remove four metric bolts on the inside of metal bumper end with a 13MM socket and set metal bumper aside.



2. Use a 7MM socket to remove the three metric screws just forward of front tire wheel well, both sides. Remove eight push pins from bottom of fascia.

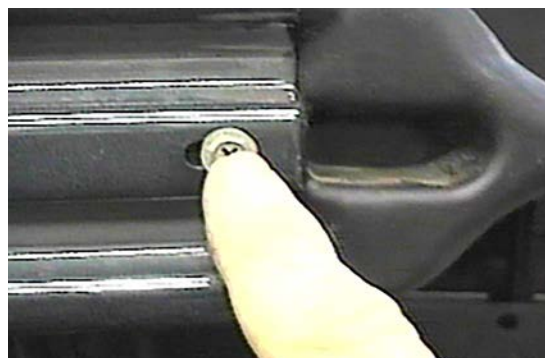

4. With a phillips screw driver, remove screw metal bumper ends. Remove end caps and set aside.



6. Remove two push pins on the air dam, both sides and set aside.



Strong As An Ox™



7. Unplug electrical connection from horn and remove horn bracket with a 10MM socket, then set aside. Factory horn bracket will not be reused.

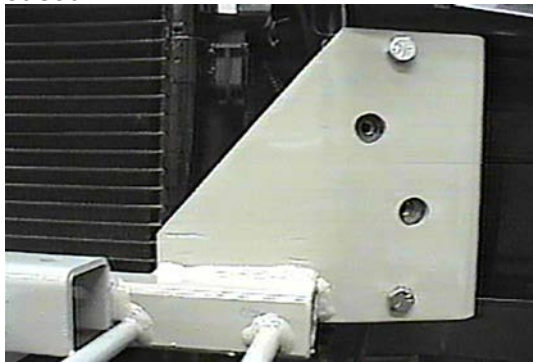

9. Hold baseplate in place so that top edge of end plates are flush with top frame webbing. Using baseplate as a template, drill four holes on the front side of baseplate with the 13/32 drill bit. Insert items 3, 4, and 5, do not tighten.



11. Using the baseplate as a template, drill four 13/32 holes on the under side of metal bumper. Insert item 2 into end of metal bumper to drill holes, tighten items 3 and 4 as shown in drawing on last page. **Be sure and use loctite on all bolts.**



8. Remove vacuum tank from drivers side with a 10MM socket and pull out of the way.

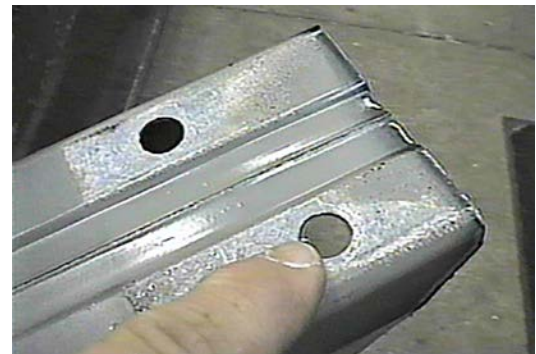

10. Drill out the four mounting holes on the back side of metal bumper with a 13/32 drill bit. Install items 6, 7, and 8 with metal bumper and tighten all bolts. **Be sure and use loctite on all bolts before tightening.**

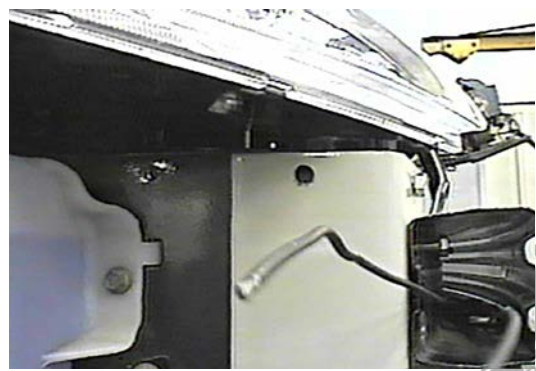

12. Drill remaining holes with 13/32 drill bit on the end plates. Use items 3, 4, and 5 according to drawing on last page. Reinstall end caps on metal bumper.



Strong As An Ox™

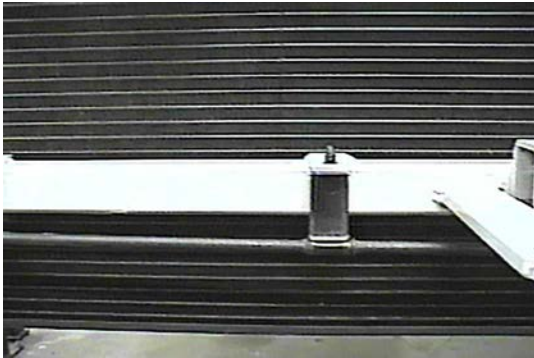

13. Insert push pin for coolant line into brackets provided on baseplate and drill 1/4 inch hole in the bottom of metal bumper for temperature sensor.

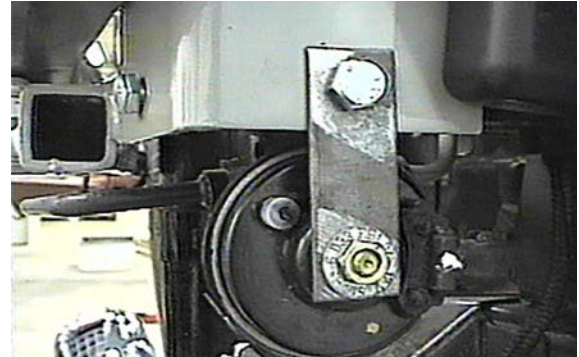

14. Reinstall horn using bracket provided, item 9. **Be sure to use loctite on all bolts before tightening.**

15. Some trimming is required to air dam below metal bumper before replacing.

16. Replace Fascia, some trimming may be required.

17. The dimensional variations between otherwise identical cars can be considerable. While the location and size of the holes in the baseplate were designed to allow for easy installation. It may be necessary to file a hole slightly.

18. Install tow bar and safety cables according to the instructions included in their packages. Do not substitute other devices if the tow bar pin or clip is lost.

19. DEALER OR INSTALLER: BE CERTAIN THE USER RECEIVES THE INSTRUCTION SHEET.



Note: If installing the BX8869, Taillight Wiring Kit, Bulb and Socket, this is the recommended location for the hole to be drilled.

IMPORTANT: Use only genuine factory replacement parts on your Base Plate. Do not substitute homemade or nontypical parts. If a bolt is lost or in need of replacement, for your safety and the preservation of your Base Plate, be sure to use a replacement bolt of the same grade (Usually Grade 5, refer to parts list). Repair parts may be ordered through your nearest **Blue Ox** dealer or distributor.



Tools Required

7MM Wrench	13MM Wrench	1/4" Drill Bit
8MM Wrench	17/32" Drill Bit	Vise Grips
10MM Wrench	9/32" Drill Bit	Loctite Blue
Phillips Screw Driver		

Parts List

Ref. No.	Qty.	Part No.	Description
1	1	61-5621	Weldment, Base Plate, BX1945
2	4	61-5590	Weldment, 3/8-16 x 1 1/4, Bolt Plate, with Wire
3	8	201-0368	3/8-16 x 1 1/4 Hex Bolt, Grd. 5, ZP
4	12	203-0010	3/8 Lock Washer, ZP
5	12	202-0003	3/8-16 Hex Nut, ZP
6	4	201-0446	8MM-1.25 x 30MM, Hex Bolt, Grd. 8.8, ZP
7	4	203-0102	8MM Lock Washer, ZP
8	4	203-0107	8MM Flat Washer, ZP
9	1	102-6080	Horn bracket
10	2	201-0979	#12-14 x 1" Self Drilling Screw, ZP
11	2	202-0047	#10-32 Hex Nut
12	2	203-0054	#10 Lock Washer
13	2	201-0192	#10-32 x 1/2 Slot, Rd. Hd. Screw
14	2	101-5822	Adapter, 4 Way Connector

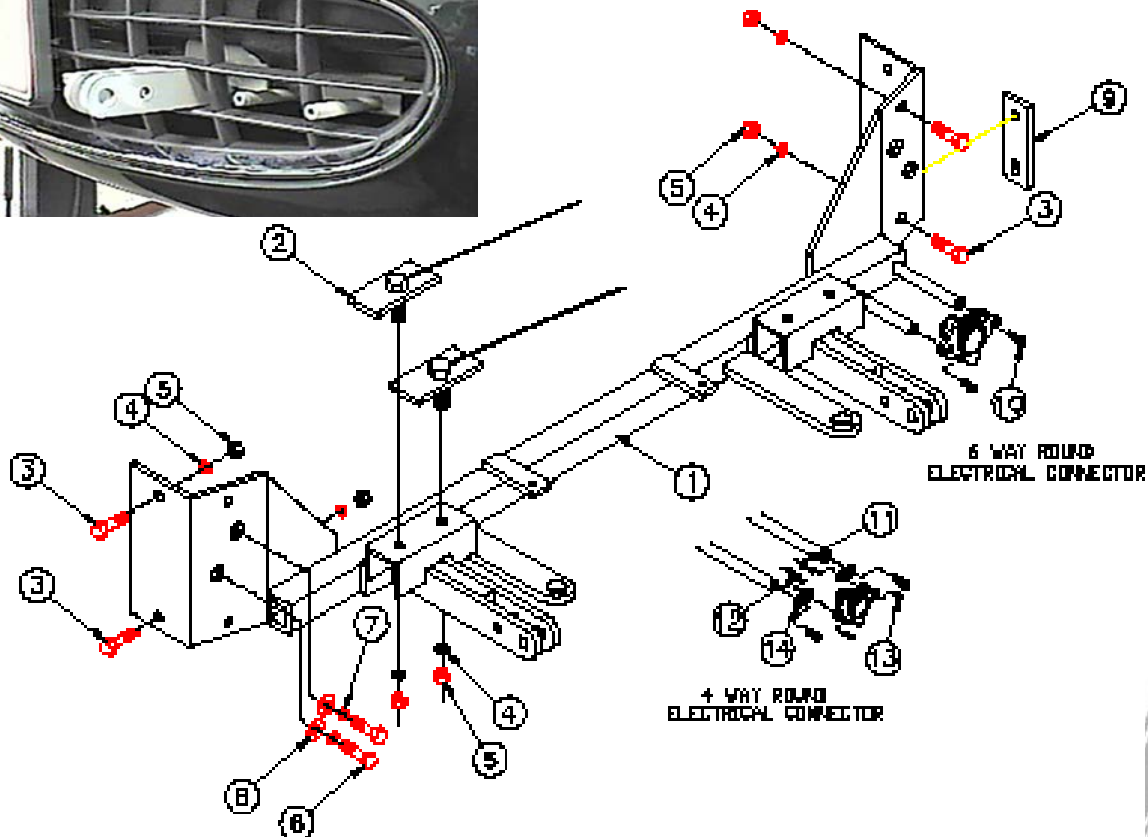

General Information

1. Ensure that your product(s) are registered online at www.blueox.com. It is crucial to register your product(s) so that you may be alerted of product offerings, updates, upgrades, maintenance and safety bulletins, and/or recalls.
2. **It is the owner's responsibility to inspect all towing equipment for cracked welds, missing or worn parts and loose bolts before each towing trip.** Be sure to use Loctite® Red on all bolts and tighten to the recommended specifications.
3. **It is the owner's responsibility to hook up all towing equipment per manufacturer's instructions/recommendations.**
4. Remove the attachment tabs when not in use (if applicable).

Notice To Baseplate Installer

1. It is YOUR responsibility to watch for:

- Oil cooler and air conditioner lines
- Electrical wires and hoses
- Missing parts or attaching points on the frame

** If the baseplate is improperly installed and is against a wire or hose, it could cause fluid leaks or electrical shorts some time after the actual baseplate installation.

Permanent Baseplate Safety Cable Installation

Permanent baseplate safety cables are strongly recommended when towing a vehicle with a tow bar. The principle function of the permanent baseplate safety cables is to prevent the towed vehicle from breaking loose in the event the connection between the frame of the towed vehicle and the baseplate fails or becomes disconnected. The cables must be connected from the baseplate to the frame rail or cross member of the vehicle's frame. The illustrations below show the possible arrangements recommended by Blue Ox®. Each permanent baseplate safety cable must have an adequate weight rating for the towing system. The weight rating of the two (2) cables together will not qualify.

Do not mount the permanent baseplate safety cables against wires, hoses or brake lines.

These permanent baseplate safety cables should remain installed as long as the baseplate is installed on the vehicle. Permanent baseplate safety cables are to be used in conjunction with, and NOT a replacement for legally required safety cables attaching the towed vehicle to the towing vehicle.

OPTION #1

Permanent Baseplate Safety Cables to Cross Member or Frame of Towed Vehicle.



OPTION #2

Permanent Baseplate Safety Cables to Cross Member or Frame of Towed Vehicle.

