

# BX2526

## 2011 Mazda 3s Hatchback

### Installation Instructions

**Please read BOTH these Installation Instructions and the General Instructions before attempting to install or operate this equipment.**

**Serial Number**

- Blue Ox® towing products and accessories are intended to be installed by Blue Ox® Dealers who are familiar with our products and have the equipment necessary and knowledge to do “fit work”. When necessary Blue Ox® Dealers can be found at [www.blueox.com](http://www.blueox.com) or by contacting our Customer Care Department at (402) 385-3051.
- Many Blue Ox® baseplates are designed to use existing holes and hardware to mount the baseplate to the towed vehicle. Even though bolts are there, do not assume they are adequate for baseplate mounting. Always use hardware supplied in the hardware kit and existing hardware specified in the Baseplate Installation Instructions.

Attachment Tab Height: 13 3/4”  
Attachment Tab Width: 24”

**Bolt Torque Specifications**  
Torque in Foot-Pounds for Metric Bolts

Bolt Size	Grade 8.8	Grade 10.9
6MM	6	8
8MM	16	22
10MM	31	40
12MM	54	70
14MM	89	117

**Confirm the towability and pre-towing procedures for your vehicle with the owner’s manual or contact the vehicle’s manufacturer for specific towing procedures.**

**Bolt Torque Specifications**  
Torque in Foot-Pounds for Inch Bolts

Bolt Size	Grade 5	Grade 8
1/4”	10	14
5/16”	19	29
3/8”	33	47
7/16”	54	78
1/2”	78	119
5/8”	154	230

**Do not use the towed vehicle for storing luggage, equipment, etc. This may cause you to exceed the towing capacity of the tow bar, baseplate, and its accessories.**



**If the front of your vehicle looks different than this, call us at (402) 385-3051.**

**! WARNING**

Failure to read and follow these instructions could result in separation of the towed vehicle from the tow bar, causing property damage, loss of towed vehicle, personal injury or death.

# BX2526

## 2011 Mazda 3s Hatchback

### Installation Instructions

#### Tools Required

8MM Socket	10MM Socket	Drill
9/16" Socket	Large Vise Grip	Tape Measure
Utility Knife	13/32" Drill Bit	1/4" Drill Bit
Flat Screwdriver	Phillips Screwdriver	Torque Wrench
Loctite® RED		

ITEM NO.	PART NUMBER	DESCRIPTION	QTY.
1	61-6958	WLDMT, BP, BX2526	1
2	61-5208	WLD, NUT PLATE, 1/4 X 1 X 1(3/8-16)w/ 14" WIRE	10
3	62-3468	ATT TAB ASSY, REM, SF/SB, 1 HOLE	2
4	102-7056	BREAKAWAY BRACKET	1
5	201-0050	1/4-20 X 3/4 HEX BOLT, GRD. 5, ZP	2
6	202-0102	1/4-20 HEX NYL NUT, ZP	2
7	201-0440	3/8-16 X 1 1/2" HEX BOLT, GRD. 5, ZP	10
8	203-0010	3/8" LOCK WASHER, ZP	10
9	202-0047	#10-32 HEX NUT	2
10	203-0054	#10 LOCK WASHER	2
11	101-5822	ADAPTER, 4 WAY CONNECTOR	2
12	201-0979	#12-14 x 1" SELF DRILLING SCREW, ZP	2
13	201-0192	#10-32-1/2" SLOT, ROUND HEAD SCREW	2

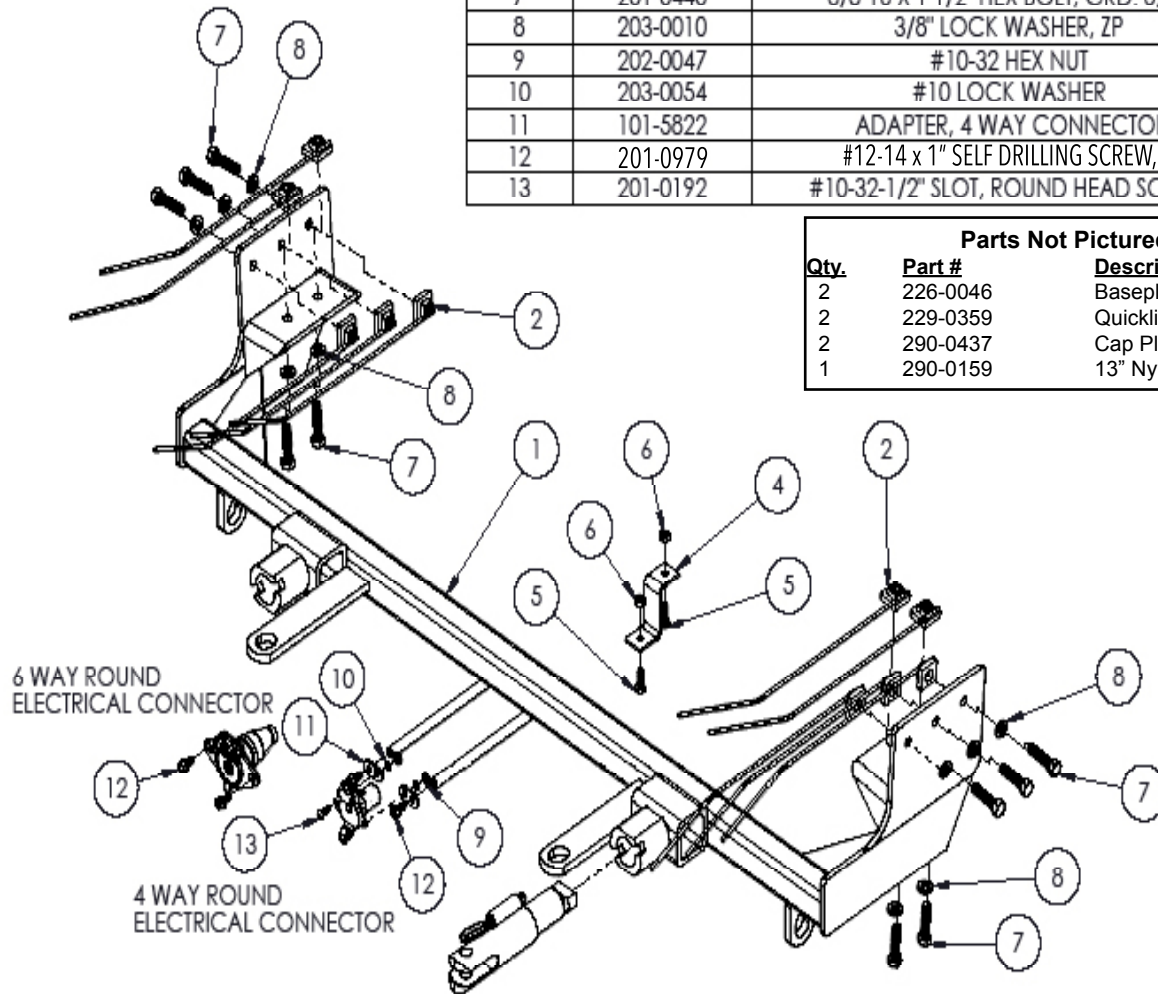

#### Parts Not Pictured:

Qty.	Part #	Description
2	226-0046	Baseplate Safety Cables
2	229-0359	Quicklink, 3/8, ZP
2	290-0437	Cap Plug, Black
1	290-0159	13" Nylon Cable Tie

#### Important:

Use only genuine factory replacement parts on your baseplate. Do NOT substitute homemade or non-typical parts. If a bolt is lost or in need of replacement, for your safety and the preservation of your baseplate, be sure to use a replacement bolt of the same grade (In most cases it will be Grade 5, please reference the parts list above). Replacement parts may be ordered through your nearest Blue Ox® Dealer or Distributor, or call our Customer Care Team at (402)385-3051. Failing to follow and/or altering these installation instructions in either installation or required equipment will void the manufacturer's warranty.

# BX2526

## 2011 Mazda 3s Hatchback

### Installation Instructions

**Removable Tabs:** Due to the design of the removable tabs, the RangeFinder II tow bar can not be used. Adapters, except the BX8833 and BX88151, can not be used with this baseplate.

**Instruction Notes:** The fascia, bumper side plates and horn with horn bracket are removed and reinstalled for the baseplate installation. Drilling is required. Trimming is required. The washer reservoir relay connection, foglights and temperature sensor are disconnected and reconnected during installation.

The dimensional variations between otherwise identical vehicles can be considerable. While the baseplate was designed for easy installation, it may be necessary to tailor the baseplate slightly to compensate for auto manufacturer's tolerances. These minor adjustments may include filing a hole slightly, bending electrical rods or bending end plates.

The BX8848 4-Diode Wiring Kit is recommended for this vehicle.

**Do not use the towed vehicle for storing luggage, equipment, etc. This may cause you to exceed the towing capacity of the tow bar, baseplate, and its accessories.**

**Handling of some cosmetic parts when installing this product may require the use of protective covers, rags, specialty tools, etc. to prevent damage.**

#### Installation Instructions:

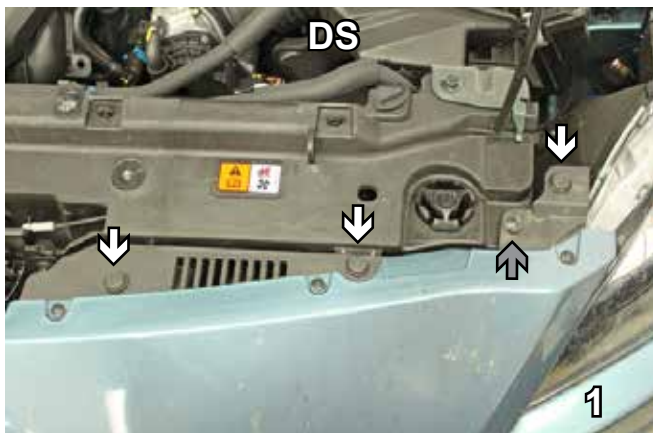

1. With flat screwdriver, remove six push pins from the top of the fascia (white arrows). With Phillips screwdriver, remove remaining two push pins (gray arrows). Set aside push pins to be reinstalled later.



2. In front of the tire, with a flat screwdriver, remove 3 push pins (2A). Also in front of the tire, with an 8MM socket or Phillips screwdriver, remove 1 bolt (2B). Do this to both sides of the vehicle. Set aside push pins and bolts to be reinstalled later.



# BX2526

## 2011 Mazda 3s Hatchback

### Installation Instructions

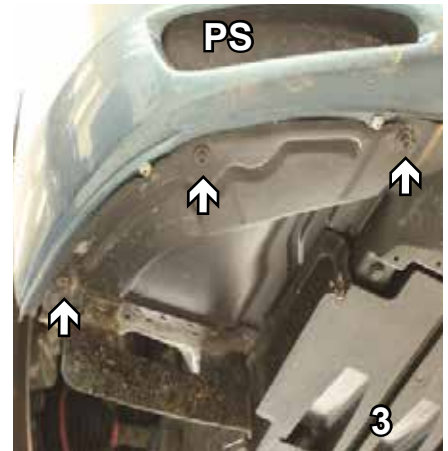
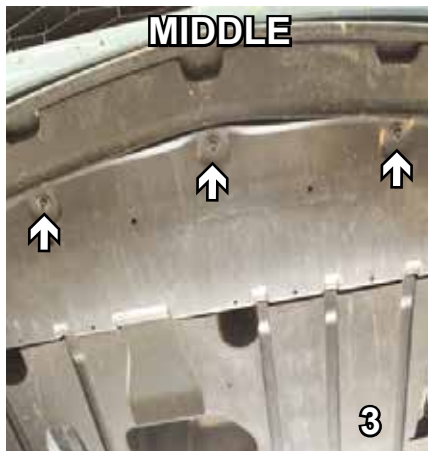
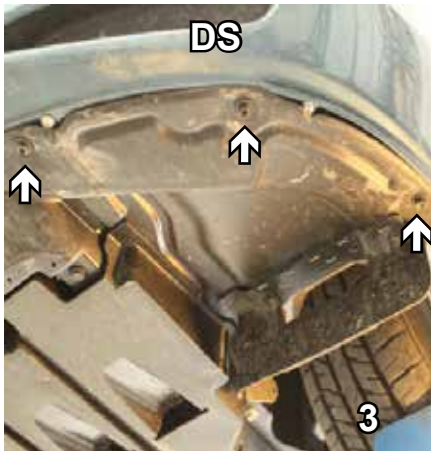

3. With an 8MM socket, remove 9 bolts from the underside of the fascia. Set bolts aside to be reinstalled later.



4. Carefully pull forward fascia on passenger side of vehicle. Behind the washer reservoir, unplug the relay connection (white arrow). Disconnect it from the washer reservoir by unclipping it from the back side of the reservoir (gray arrow). Move relay connection aside to be reconnected later.

5. Pull down bellypan underneath the fascia. With a 10MM socket, remove two bolts (one bolt found on each side of the vehicle). Set bolts aside to be reinstalled later.



6. Before completely removing the fascia, on passenger side only, disconnect the fog light. Carefully finish removing fascia and set aside to be reinstalled later.

7. Unclip temperature sensor in the front of the radiator, directly under metal bumper and move aside. The temperature sensor will be relocated at a later point in the instructions.

# BX2526

## 2011 Mazda 3s Hatchback

### Installation Instructions

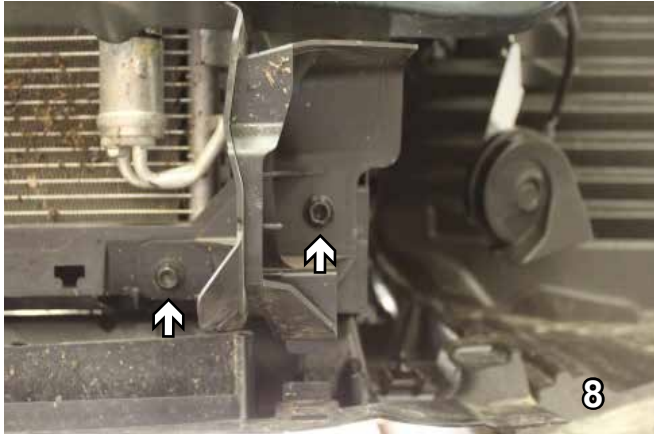

8. With 10MM socket, remove two bolts from the bumper side plate. Set bolts and bumper side plate aside to be reinstalled later. Do this to both sides of the vehicle.
9. On driver's side, with a 10MM socket, remove bolt from horn bracket. Set horn bracket and horn aside to be reinstalled later.

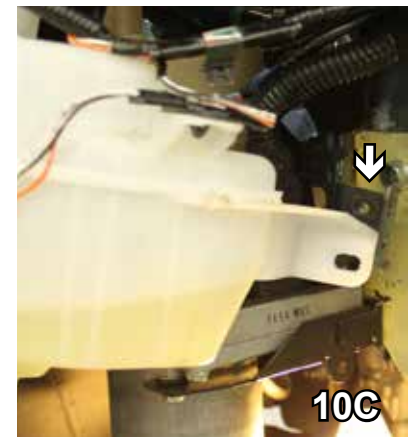

10. On passenger's side, unclip wire harness from bracket on washer reservoir (10A). With a 10MM socket, remove bolt from washer reservoir (10B). Move washer reservoir aside to allow for more room when mounting the baseplate (10C).

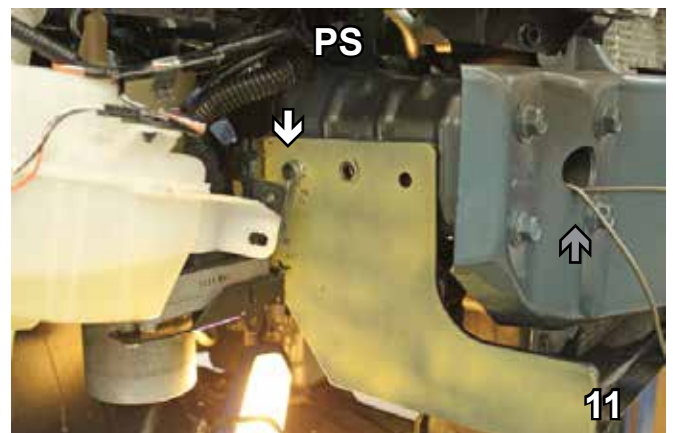
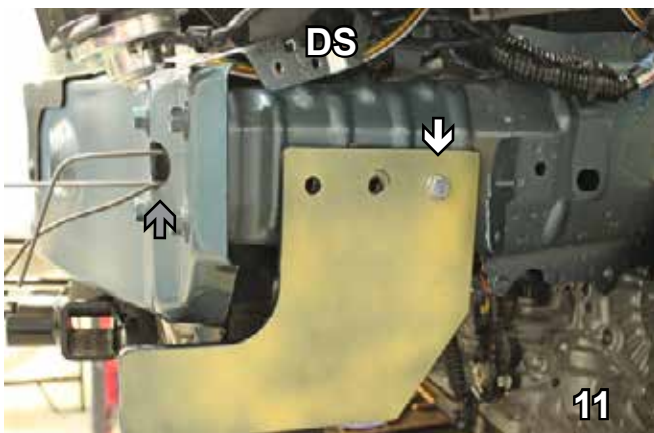

11. When mounting baseplate to the vehicle, use the existing back hole on the bumper horn to align and keep level. Start the 3/8-16 x 1 1/2 hex bolt in the back hole with 3/8" lock washer and nut plate (white arrow). Insert nut plate through existing hole in the front of the bumper (gray arrow). Do this to both sides while always ensuring baseplate remains level. Tighten bolts with Loctite Red. ***(Baseplate is painted yellow for demonstrative purposes only.)***



# BX2526

## 2011 Mazda 3s Hatchback

### Installation Instructions

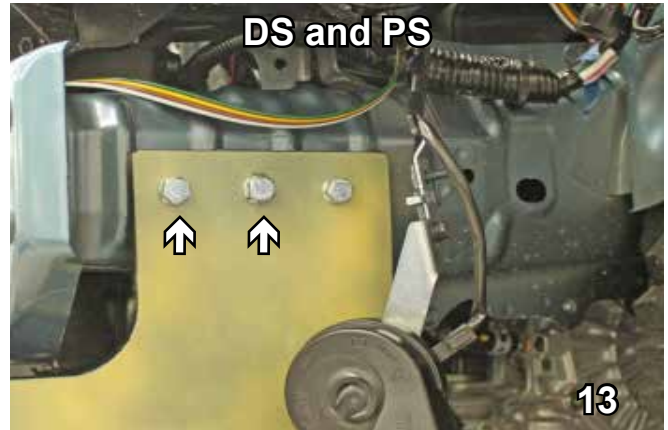
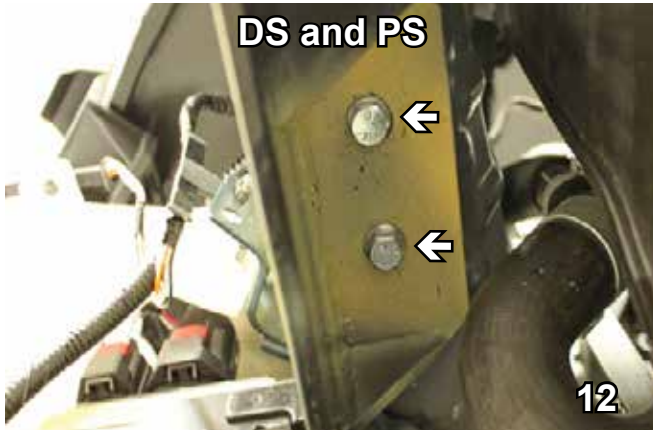

12. Underneath baseplate, with a 13/32" drill bit, drill remaining four holes (2 on driver's side, 2 on passenger's side). Insert 3/8-16 x 1 1/2 hex bolt, 3/8" lock washer and nut plate in each hole. Do this to both sides. Tighten all bolts with Loctite Red.
13. On the side of the baseplate, with a 13/32" drill bit, drill remaining four holes (2 on driver's side, 2 on passenger's side). Insert 3/8-16 x 1 1/2 hex bolt, 3/8" lock washer and nut plate in each hole. Do this to both sides. Tighten all bolts with Loctite Red.

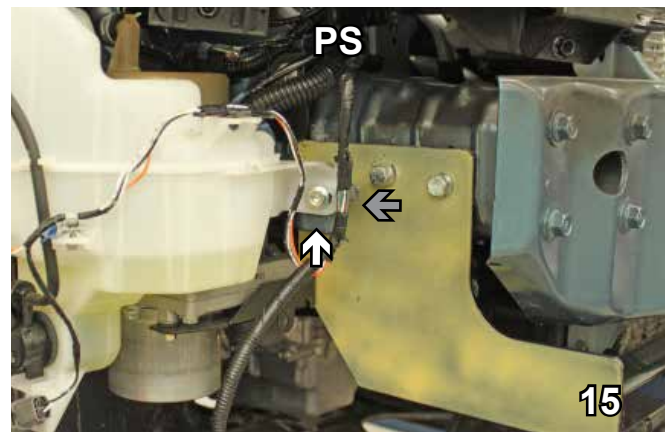

14. On driver's side, with large vise grip, bend horn mounting bracket out to accommodate baseplate. Reattach horn bracket and horn using existing hardware.
15. On passenger's side, reattach washer reservoir to the original bracket using existing hardware (white arrow). Reclip wire harness to the original bracket (gray arrow).

**BE SURE TO USE LOCTITE® RED ON ALL BOLTS BEFORE TIGHTENING. TIGHTEN ALL BOLTS ACCORDING TO THE TORQUE CHART ON THE FRONT PAGE OF THESE INSTRUCTIONS OR ON PAGE 3 OF THE BASEPLATE TOWING GENERAL INSTRUCTIONS.**

**When using power drills be aware of the dangers of torque and drill bit length.**

# BX2526

## 2011 Mazda 3s Hatchback

### Installation Instructions

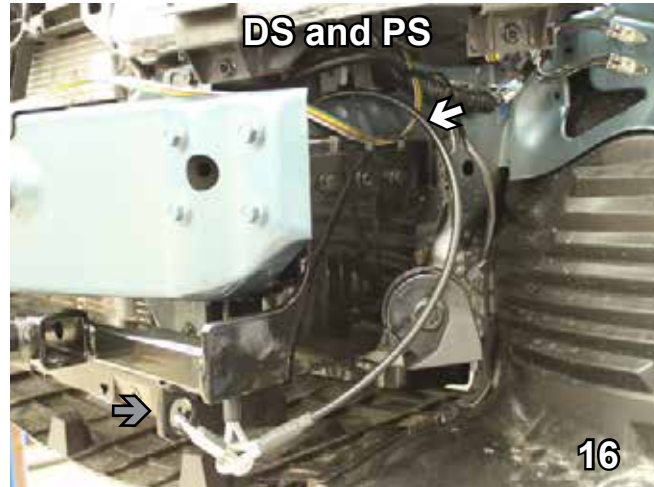

16. Attach the permanent baseplate safety cables to the provided convenience link on the baseplate (gray arrow). The photo to the left shows the recommended installation of the cables to frame of vehicle (white arrow). Additional options may interfere with suggested mounting; in this case secure the cables to a solid piece of the frame as described in the instructions included with the permanent baseplate safety cables. Be sure the safety cables do not rub against any hoses or moving parts. Do this to both sides of the vehicle.

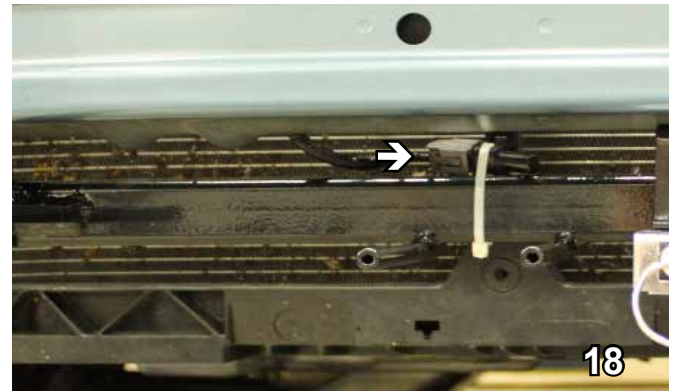
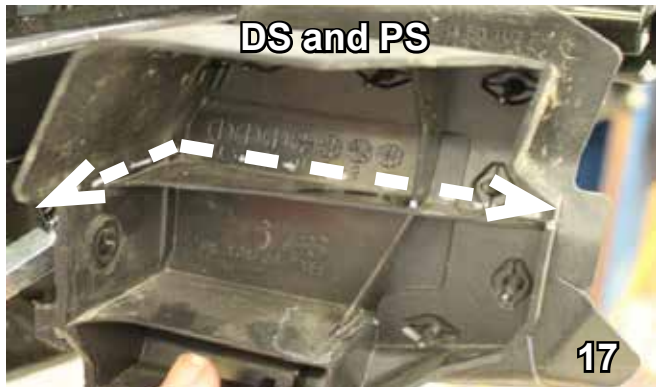

17. Before reinstalling bumper side plate, trimming is required. With a utility knife, trim bumper side plate as shown above. Reinstall bumper side plate using existing hardware. Do this to both sides.
18. Using the provided nylon cable tie, mount temperature sensor to the top of the baseplate.

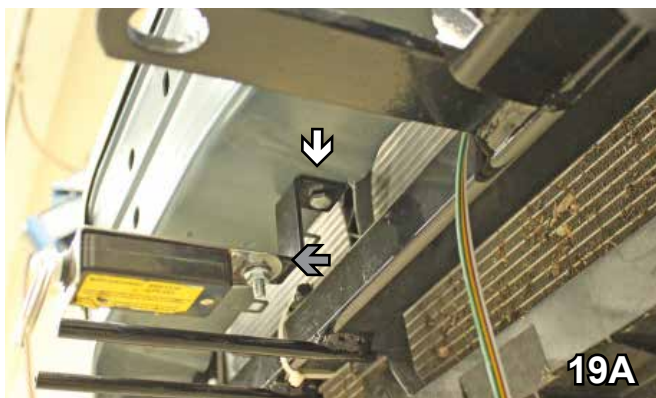

19. OPTIONAL: You can install the breakaway bracket and breakaway on either the driver's side or passenger's side of the vehicle. With a 1/4" drill bit, drill a hole through the bottom side of the bumper. Insert 1/4-20 x 3/4 hex bolt (white arrow - 19A) with 1/4-20 hex nyl nut to secure the bracket (19B). Attach breakaway to the bracket with 1/4-20 x 3/4 hex bolt with 1/4-20 hex nyl nut (gray arrow - 19A).

# BX2526

## 2011 Mazda 3s Hatchback

### Installation Instructions



20. Hold fascia up as close to original position as possible. With a utility knife, trim fascia to allow baseplate attachment tabs, convenience links and breakaway, if applicable, to come through.
21. Reinstall fascia.

Install the tow bar and safety cables according to the instructions provided in their packages. When demonstrating this to the customer, be sure to include all the contents and packages.

Do not substitute other devices if the tow bar pins and clips are misplaced.

**DEALER or INSTALLER:**  
Be certain the user receives the  
instruction sheets for their products.

Be sure that **ALL** electrical connections  
are plugged in properly and functioning  
**BEFORE** installing the fascia.



# BX2526

## 2011 Mazda 3s Hatchback

### Installation Instructions



Shown with removable tabs installed



Shown without removable tabs installed

### CUSTOMER SERVICE COMMITMENT

Blue Ox is committed to providing you with exceptional customer care throughout your lifetime with our products. Our team is here to assist you with any questions you may have regarding the performance of your product. Simply call (402) 385-3051 and you can speak with our customer care team.

Additionally, please visit our website to see which rallies our Destination America team will be attending. For a nominal fee, our service technician will service your towing system to ensure it is in proper working condition. Also, as a commitment to our customers, should you visit our factory, you can stay at our full service Blue Ox campground at no charge along with enjoying a factory tour.

Again, thank you for being our customer and for the confidence you have shown in the performance of our products. It is because of customers like you we enjoy the success we have today.

**If the baseplate is in an accident, it must be replaced. DO NOT use it again! An accident can cause unseen damage and using it again could result in more damage or serious injury. DO NOT use the baseplate if it is damaged or missing parts.**



© 2011 Blue Ox  
One Mill Road, Industrial Park  
Pender, Nebraska 68047  
Phone: (402) 385-3051  
Fax: (402) 385-3360  
[www.blueox.com](http://www.blueox.com)

# General Information

1. Ensure that your product(s) are registered online at [www.blueox.com](http://www.blueox.com). It is crucial to register your product(s) so that you may be alerted of product offerings, updates, upgrades, maintenance and safety bulletins, and/or recalls.
2. **It is the owner's responsibility to inspect all towing equipment for cracked welds, missing or worn parts and loose bolts before each towing trip.** Be sure to use Loctite® Red on all bolts and tighten to the recommended specifications.
3. **It is the owner's responsibility to hook up all towing equipment per manufacturer's instructions/recommendations.**
4. Remove the attachment tabs when not in use (if applicable).

## Notice To Baseplate Installer

### 1. It is YOUR responsibility to watch for:

- Oil cooler and air conditioner lines
- Electrical wires and hoses
- Missing parts or attaching points on the frame

\*\* If the baseplate is improperly installed and is against a wire or hose, it could cause fluid leaks or electrical shorts some time after the actual baseplate installation.

## Permanent Baseplate Safety Cable Installation

Permanent baseplate safety cables are strongly recommended when towing a vehicle with a tow bar. The principle function of the permanent baseplate safety cables is to prevent the towed vehicle from breaking loose in the event the connection between the frame of the towed vehicle and the baseplate fails or becomes disconnected. The cables must be connected from the baseplate to the frame rail or cross member of the vehicle's frame. The illustrations below show the possible arrangements recommended by Blue Ox®. Each permanent baseplate safety cable must have an adequate weight rating for the towing system. The weight rating of the two (2) cables together will not qualify.

***Do not mount the permanent baseplate safety cables against wires, hoses or brake lines.***

These permanent baseplate safety cables should remain installed as long as the baseplate is installed on the vehicle. Permanent baseplate safety cables are to be used in conjunction with, and NOT a replacement for legally required safety cables attaching the towed vehicle to the towing vehicle.

### OPTION #1

Permanent Baseplate Safety Cables to Cross Member or Frame of Towed Vehicle.

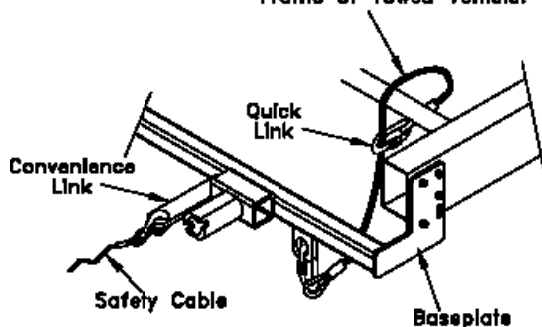

### OPTION #2

Permanent Baseplate Safety Cables to Cross Member or Frame of Towed Vehicle.

