

Please read **BOTH** these Installation Instructions and the General Towing Instructions before attempting to install or operate this equipment.

- Blue Ox® towing products and accessories are intended to be installed by Blue Ox® Dealers who are familiar with our products and have the equipment and knowledge to do “fit work”. When necessary, Blue Ox® Dealers can be found at www.blueox.com or by contacting our Customer Care Department at (402) 385-3051
- Many Blue Ox® Baseplates are designed to use existing holes and hardware to mount the baseplate to the towed vehicle. Even though bolts are there, do not assume they are adequate for baseplate mounting. Always use hardware supplied in the hardware kit or existing hardware specified in the Baseplate Installation Instructions.

Attachment Tab Height: 12”
Attachment Tab Width: 20 1/2”

Bolt Torque Specifications

Torque in Foot-Pounds for Metric Bolts

Bolt Size	Grade 8.8	Grade 10.9
6MM	6	8
8MM	16	22
10MM	31	40
12MM	54	70
14MM	89	117

Confirm the towability and pre-towing procedures for your vehicle with the owner’s manual or contact the vehicle’s manufacturer for specific towing procedures.

Bolt Torque Specifications

Torque in Foot-Pounds for Inch Bolts

Bolt Size	Grade 5	Grade 8
1/4”	10	14
5/16”	19	29
3/8”	33	47
7/16”	54	78
1/2”	78	119
5/8”	154	230

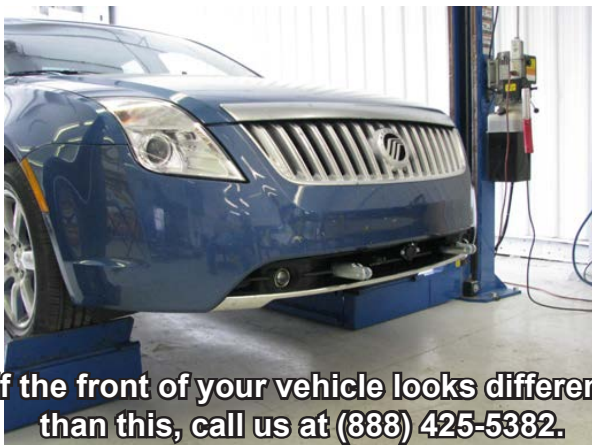

If the front of your vehicle looks different than this, call us at (888) 425-5382.

! WARNING

Failure to read and follow these instructions could result in separation of the towed vehicle from the tow bar, causing property damage, loss of towed vehicle, personal injury or death.

BX2616 2010 Mercury Milan (Include Hybrid)

Installation Instructions

Parts List

Ref. No.	Qty.	Part #	Description
1	1	61-6705	WLDM'T, BP, BX2616
2	2	61-5208	WLD, NUT PLT, 1/4X1X1, 3/8"/14"WIRE
3	6	107-2683	SPACER TUBE, 3/4 X .406 (ID)X 1"
4	4	201-0444	3/8-16 X 2 HEX BOLT GRADE 5 ZP.
5	2	201-0440	3/8-16 X 1 1/2 HEX BOLT, GRD.5, ZP
6	6	203-0010	3/8 LOCK WASHER, ZP
7	4	202-0090	3/8-16 HEX NYL. INS. LOCK NUT, ZP
8	2	201-0979	#12-14 X 1" SELF DRILLING SCREW, ZP
9	2	201-0192	10-32 X 1/2 SLOT, RD. HD. SCREW
10	2	203-0054	#10 LOCK WASHER
11	2	202-0047	#10-32 HEX NUT
12	2	101-5822	ADAPTER, 4 WAY CONNECTOR
13	2	62-3469	ATT TAB ASSY, REM, SF/LB, 1 HOLE
	2	201-0702	6MM-1.00 X 45MM HEX BOLT, GRD 8.8,
	2	203-0001	1/4 FLAT WASHER, ZP
	2	203-0161	6MM, LOCK WASHER, ZP
	2	226-0046	BASEPLATE SAFETY CABLE, 36" CL III (Not Shown)
	2	229-0359	QUICKLINK, 3/8, ZP (Not Shown)
	2	290-0437	RECEIVER, CAP PLUG (BLK) (Not Shown)

Tools Required

7MM Socket	Utility Knife
10MM Socket/Wrench	Pliers
9/16" Socket	Tape Measure
Large Vise Grips	1 1/4" Hole Saw
Drill	13/32" Drill Bit
Flat Screwdriver	Loctite® RED

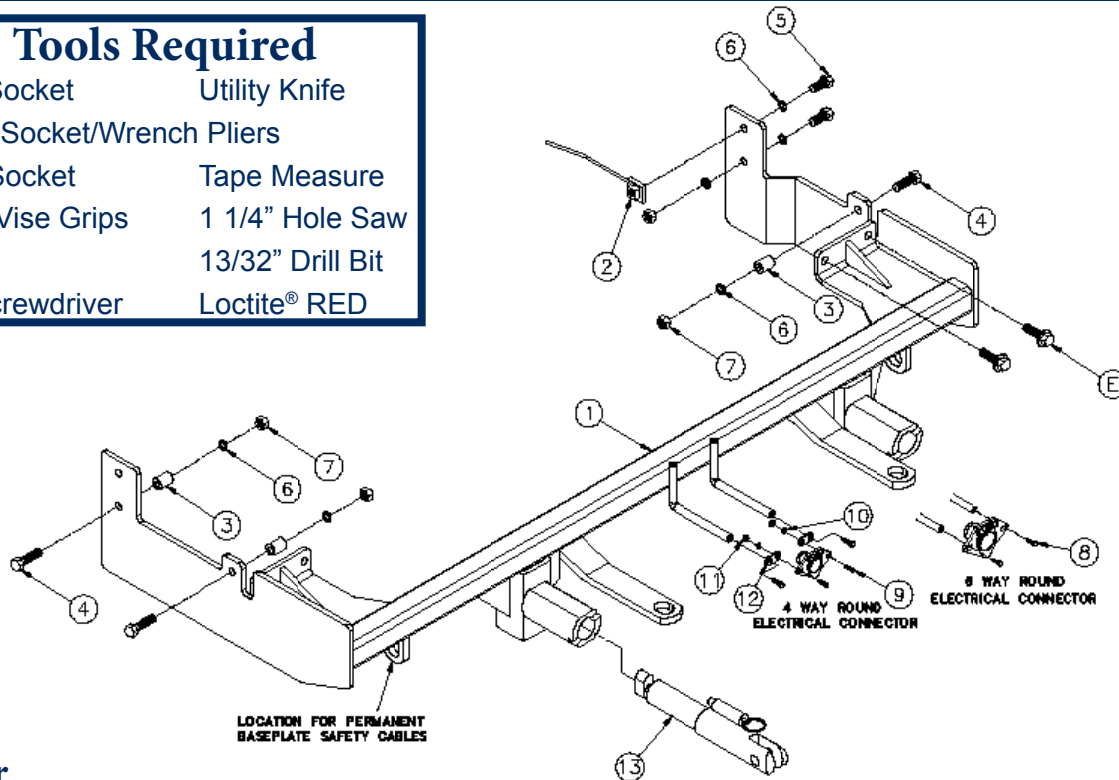

Impor.....

Use only genuine factory replacement parts on your baseplate. Do **NOT** substitute homemade or non-typical parts. If a bolt is lost or in need of replacement, for your safety and the preservation of your baseplate, be sure to use a replacement bolt of the same grade (In most cases it will be Grade 5, please reference the parts list above). Replacement parts may be ordered through your nearest Blue Ox® Dealer or Distributor. Failing to follow and/or altering these installation instructions in either installation or required equipment will void the manufacturer's warranty. Towing behind a non-motorized vehicle will void the warranty.

BX2616 2010 Mercury Milan (Include Hybrid)

Installation Instructions

Attachment Tabs:

Motorhome mount tow bars are recommended for use with this baseplate. Due to the design of the removable tabs, the RangeFinderII, Adventurer and Ambassador tow bars can not be used. The Acclaim tow bar may be used, but will not fold and store on the front of the vehicle. Adapters, except the BX8833 and BX88151, can not be used with this baseplate.

Installation Notes: The front fascia, plastic bumper cover, air baffle, and washer reservoir are removed and replaced during installation. Drilling is required. The bumper cover, fascia, air baffle and washer reservoir must be trimmed.

The dimensional variations between otherwise identical vehicles can be considerable.

While the baseplate was designed for easy installation, it may be necessary to tailor the baseplate slightly to compensate for auto manufacturer's tolerances. These minor adjustments may include filing a hole slightly, bending electrical rods or bending end plates.

The BX8848 4-Diode Wiring Kit is recommended for this vehicle.

Handling of some cosmetic parts when installing this product may require the use of protective covers, rags, specialty tools, etc. to prevent damage.

Installation Instructions:

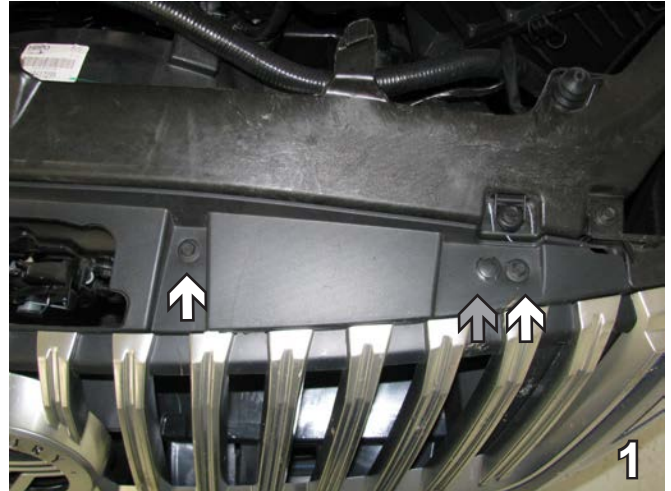

1. Using the 10mm socket, remove two metric bolts from the top of the grille (white arrows). Remove one pushpin from the top of the grille (gray arrow). Do this to both sides of the vehicle. Set bolts and pushpin aside to be reinstalled later.



2. Just forward of the front tire, inside the wheel well, remove three pushpins. Do this to both sides of the vehicle. Set pushpins aside to be reinstalled later.

BX2616 2010 Mercury Milan (Include Hybrid) Installation Instructions

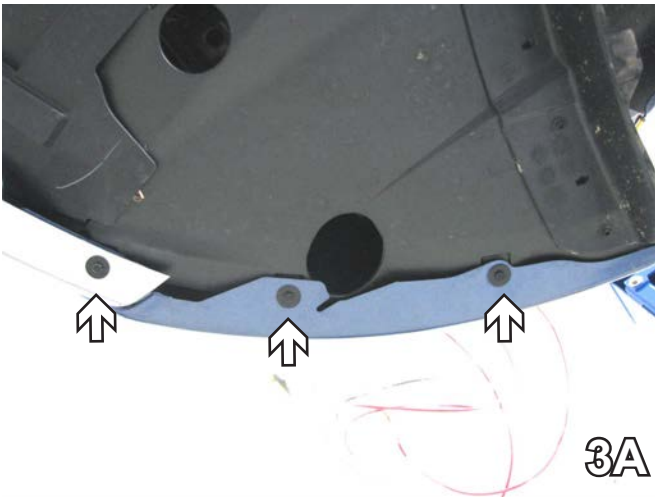

3. Using the 7mm socket, remove five metric bolts from underneath along the bottom front of the fascia. Do this to both sides of the vehicle. Set bolts aside to be reinstalled later.



4. Grab, lift and pull the fascia straight out to remove it. When you come to the tabs, use a screwdriver to lift up and pop the fascia out. Do this to both sides of the vehicle. Set fascia aside carefully to be reinstalled later.
5. Remove the plastic bumper cover by pushing down on the eight tabs across the top to release. Set the bumper cover aside to be reinstalled later.

BX2616
2010 Mercury Milan (Includes
Hybrid) Installation Instructions

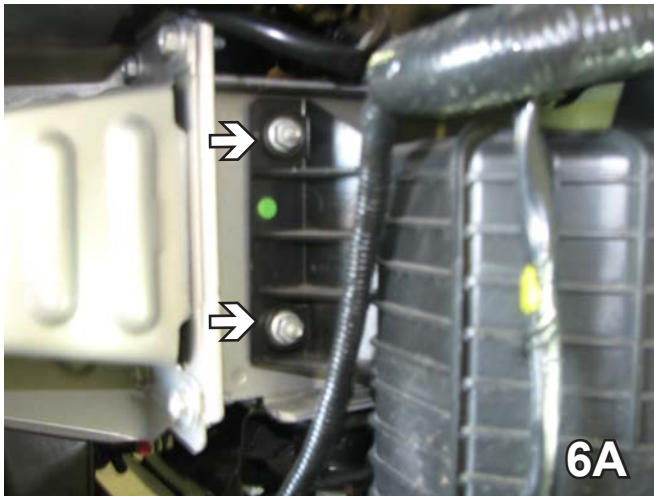

6. On the driver side use the 13MM socket to remove the three metric bolts from the air baffle, two in the front and one in the back. Set the bolts and air baffle aside to be reinstalled later.

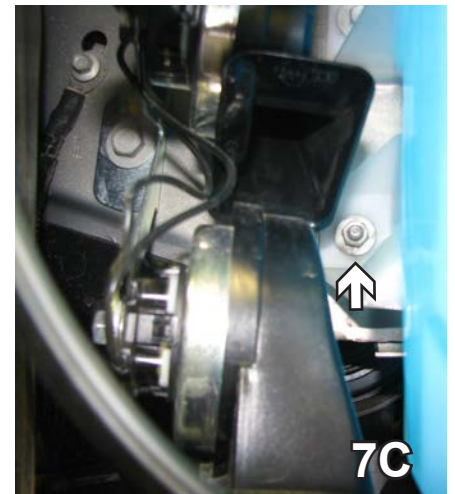
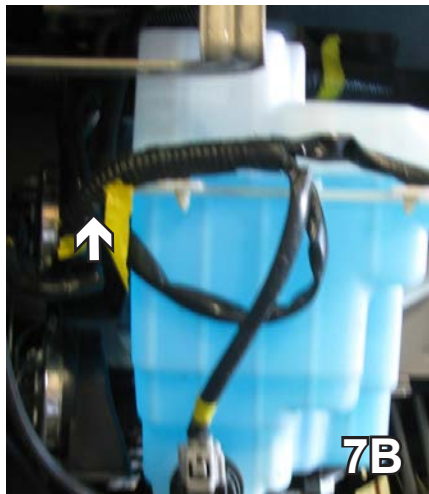

7. On the passenger side using the 10mm socket, remove three metric bolts from the washer reservoir, one on the right side (see 7A) and two on the left (see 7B & 7C). Disconnect the hoses and the wiring, plug the hoses. Set washer reservoir and bolts aside to be reinstalled later.

BX2616 2010 Mercury Milan (Includes Hybrid) Installation Instructions

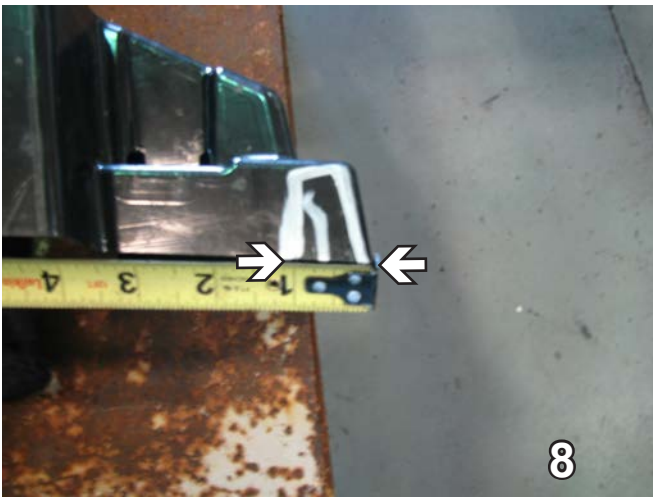

8. On the bottom side of the plastic bumper cover, using a utility knife, notch out the corner. Go over 1", then up, across and back. Do this to both sides.

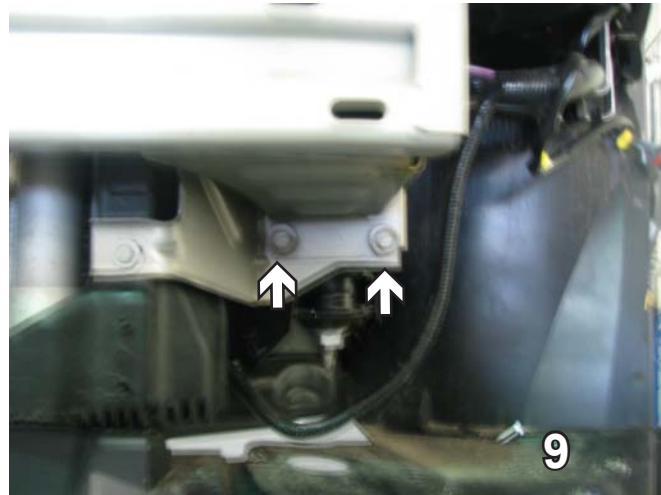

9. Using the 13MM socket, remove two bolts from underneath the bumper. Do this to both sides. Set the bolts aside to be reinstalled later.



10. Slide the baseplate up into place, start the two existing bolts. Do this to both sides of the vehicle.

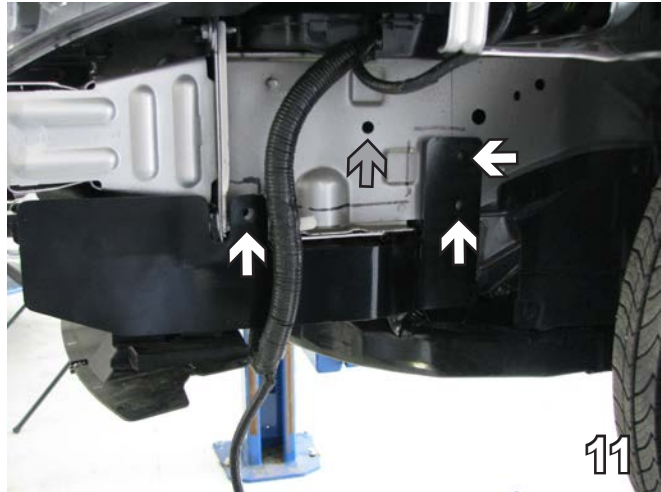

11. On the driver side, the plate is bent. You may need to pull it out a little to get by the ridge. Be sure the baseplate is level with respect to the vehicle frame. Using the baseplate as a template with the 13/32" drill bit, drill the three holes on the side (white arrows). Using the 1 1/4" hole saw, drill a hole so that nut plates may be inserted into the frame (gray arrow). Do this to both sides of the vehicle.

When using power drills be aware of the dangers of torque and drill bit length.

BX2616 2010 Mercury Milan (Includes Hybrid) Installation Instructions



12. On the passenger side, insert 3/8-16 x 2" hex bolts in all holes, 1" spacer tubes are placed between the baseplate and the frame for each hole. The front hole and the bottom back hole have 3/8" lock washers with 3/8-16 hex nuts (white arrows). The top back hole has the 3/8" lock washer on this side and a 3/8-16 nut plate inserted into the drilled hole (gray arrow). Be sure to use Loctite on all the bolts.



13. On the driver side, insert 3/8-16 x 2" hex bolt in the front hole (gray arrow), a 1" spacer tube is placed between the baseplate and the frame, 3/8" lock washer with 3/8-16 hex nut. The back holes (white arrows) have 3/8-16 x 1 1/2" hex bolts. The bottom back hole has 3/8" lock washer with 3/8-16 hex nut. The top back hole has the 3/8" lock washer on this side and a 3/8-16 nut plate inserted into the drilled hole. Be sure to use Loctite on all the bolts.

BE SURE TO USE LOCTITE® RED ON ALL BOLTS BEFORE TIGHTENING. TIGHTEN ALL BOLTS ACCORDING TO THE TORQUE CHART ON THE FRONT PAGE OF THESE INSTRUCTIONS OR ON PAGE 3 OF THE BASEPLATE TOWING GENERAL INSTRUCTIONS.



14. On the driver side, trim the corner of the air baffle up to the rubber as shown.



15. Reattach the air baffle.

BX2616 2010 Mercury Milan (Includes Hybrid) Installation Instructions



16. Attach the permanent baseplate safety cables to the provided convenience link on the baseplate (see grey arrow). The photo above shows the recommended installation of the cables to frame of vehicle (see white arrow). Additional options may interfere with suggested mounting; in this case secure the cables to a solid piece of the frame as described in the instructions included with the permanent baseplate safety cables. Be sure the safety cables do not rub against any hoses or moving parts. Do this to both sides of the vehicle.

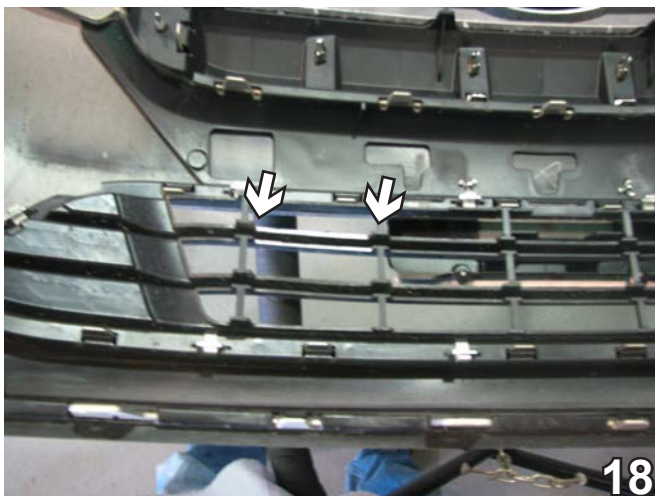
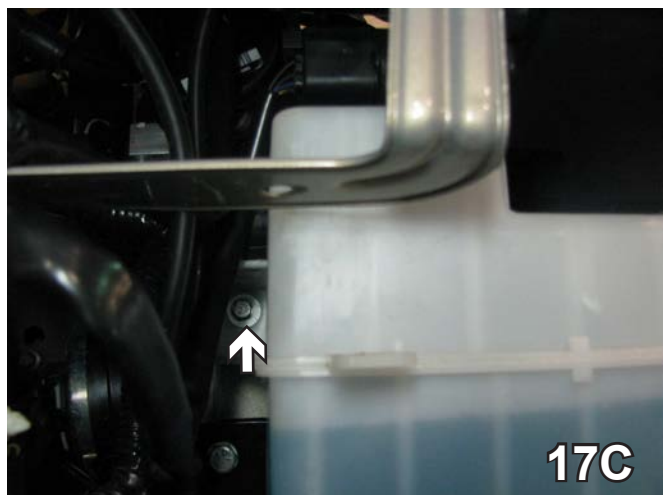
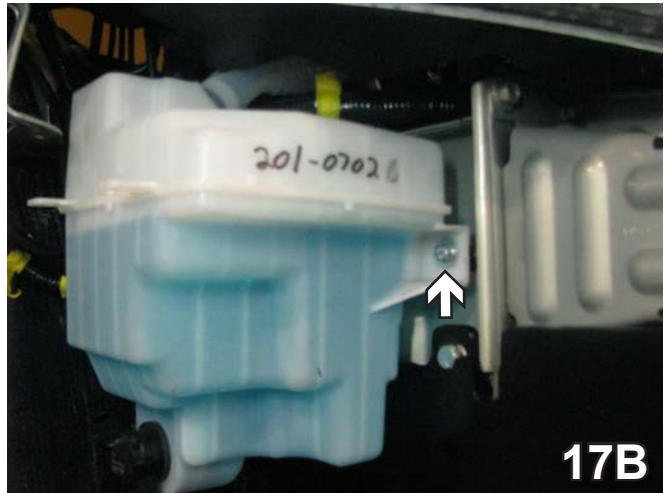
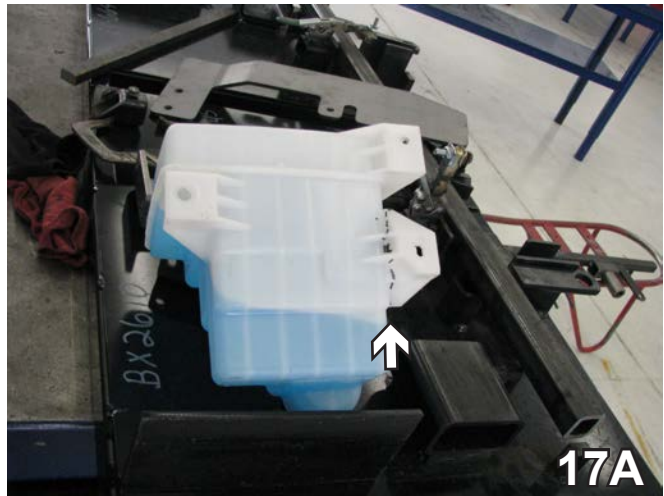

18. Using the utility knife, on the back side of the fascia, cut out the first long top rib. Do this to both sides of the fascia. Reinstall the fascia.

Be sure that **ALL** electrical connections are plugged in properly and functioning **BEFORE** installing the fascia.

17. Using the utility knife, cut the tab off of the washer reservoir. Reinstall the washer reservoir. Use 6MM-1 x 45MM hex bolts with 6MM lock washers and 1/4" flat washers. Insert 1" spacers between the washer reservoir and the frame for each hole. Reconnect the hoses and the wiring. Reinstall the plastic bumper cover. Tighten all bolts completely.

BX2616 2010 Mercury Milan (Includes Hybrid) Installation Instructions

Install the tow bar and safety cables according to the instructions provided in their packages. When demonstrating this to the customer, be sure to include all the contents and packages.

Do **NOT** substitute other devices if the tow bar pins and clips are misplaced.



If the baseplate is in an accident, it must be replaced. **DO NOT** use it again! An accident can cause unseen damage and using it again could result in more damage or serious injury. **DO NOT** use the baseplate if it is damaged or missing parts.

DEALER or INSTALLER:
Be certain the user receives the instruction sheets for their products.

CUSTOMER SERVICE COMMITMENT

Blue Ox is committed to providing you with exceptional customer care throughout your lifetime with our products. Our team is here to assist you with any questions you may have regarding the performance of your product. Simply call 1-800-228-9289 and you can speak with our customer care team.

Additionally, please visit our website to see which rallies our Destination America team will be attending. For a nominal fee, our service technician will service your towing system to ensure it's in proper working condition. Also as a commitment to our customers, should you visit our factory you can stay at our full service Blue Ox campground at no charge along with enjoying a factory tour.

Again thank you for being our customer and for the confidence you have shown in the performance of our products. It is because of customers like you we enjoy the success we have today.



© 2010 Blue Ox
One Mill Road, Industrial Park
Pender, Nebraska 68047
Phone: (402) 385-3051 • Fax: (402) 385-3360
www.blueox.com

General Information

1. Ensure that your product(s) are registered online at www.blueox.com. It is crucial to register your product(s) so that you may be alerted of product offerings, updates, upgrades, maintenance and safety bulletins, and/or recalls.
2. **It is the owner's responsibility to inspect all towing equipment for cracked welds, missing or worn parts and loose bolts before each towing trip.** Be sure to use Loctite® Red on all bolts and tighten to the recommended specifications.
3. **It is the owner's responsibility to hook up all towing equipment per manufacturer's instructions/recommendations.**
4. Remove the attachment tabs when not in use (if applicable).

Notice To Baseplate Installer

1. It is YOUR responsibility to watch for:

- Oil cooler and air conditioner lines
- Electrical wires and hoses
- Missing parts or attaching points on the frame

** If the baseplate is improperly installed and is against a wire or hose, it could cause fluid leaks or electrical shorts some time after the actual baseplate installation.

Permanent Baseplate Safety Cable Installation

Permanent baseplate safety cables are strongly recommended when towing a vehicle with a tow bar. The principle function of the permanent baseplate safety cables is to prevent the towed vehicle from breaking loose in the event the connection between the frame of the towed vehicle and the baseplate fails or becomes disconnected. The cables must be connected from the baseplate to the frame rail or cross member of the vehicle's frame. The illustrations below show the possible arrangements recommended by Blue Ox®. Each permanent baseplate safety cable must have an adequate weight rating for the towing system. The weight rating of the two (2) cables together will not qualify.

Do not mount the permanent baseplate safety cables against wires, hoses or brake lines.

These permanent baseplate safety cables should remain installed as long as the baseplate is installed on the vehicle. Permanent baseplate safety cables are to be used in conjunction with, and NOT a replacement for legally required safety cables attaching the towed vehicle to the towing vehicle.

OPTION #1

Permanent Baseplate Safety Cables to Cross Member or Frame of Towed Vehicle.

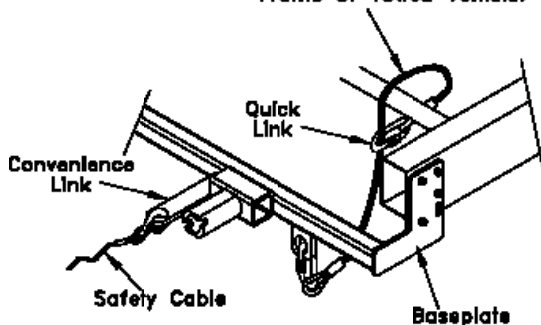

OPTION #2

Permanent Baseplate Safety Cables to Cross Member or Frame of Towed Vehicle.

