



# BX3829

## 2010-12 VW CC Sport 2008 VW Passet Turbo Installation Instructions

Please read **BOTH** these Installation Instructions and the General Instructions prior to installing or operating this equipment.

- Blue Ox® towing products and accessories are intended to be installed by Blue Ox® Dealers who are familiar with our products and have the equipment and knowledge necessary to do “fit work”. If needed, Blue Ox® Dealers can be found at [www.blueox.com](http://www.blueox.com) or by contacting our Customer Care Department at (402) 385-3051.
- Many Blue Ox® baseplates are designed to use existing holes and hardware to mount the baseplate to the towed vehicle. Even though bolts are there, do not assume they are adequate for baseplate mounting. Always use the hardware supplied in the hardware kit and existing hardware as specified in the installation instructions.

**Serial Number**

**Attachment Tab Height: 11-1/2”**

**Attachment Tab Width: 20”**

### Bolt Torque Specifications

Torque in Foot-Pounds for Inch Bolts

Bolt Size	Grade 5	Grade 8
1/4”	10	14
5/16”	19	29
3/8”	33	47
7/16”	54	78
1/2”	78	119
5/8”	154	230
3/4”	257	380



If the front of your vehicle looks different than this, please contact us at (402)385-3051.

### Bolt Torque Specifications

Torque in Foot-Pounds for Metric Bolts

Bolt Size	Grade 8.8	Grade 10.9
6MM	6	8
8MM	16	22
10MM	31	40
12MM	54	70
14MM	89	117
16MM	161	230
18MM	222	318



## WARNING

Failure to read and follow these instructions could result in separation of the towed vehicle from the tow bar, causing property damage, loss of towed vehicle, personal injury or death.

**Reference your vehicle owner’s manual for manufacturer’s towing specifications.**

BX3829  
2010-12 VW CC Sport  
2008 VW Passat Turbo  
Installation Instructions

**Instruction Notes:** The fascia and metal bumper are removed and reinstalled for the baseplate installation. Some drilling and trimming is required.

Place all components that are removed on a flat, sturdy surface. All items will be reinstalled unless otherwise noted after the baseplate is installed.

The dimensional variations between otherwise identical vehicles can be considerable. While the baseplate was designed for easy installation, it may be necessary to tailor the baseplate slightly to compensate for vehicle manufacturer's tolerances.

The BX8869 Tail Light Wiring Kit is recommended for this vehicle.



Drill a hole according to the tail light wiring kit instructions.

### **NOTICE**

- Handling of some cosmetic parts when installing this product may require the use of protective covers, rags, specialty tools, etc. to prevent damage.
- When using power drills be aware of the dangers of torque and drill bit length.
- When using a reciprocating saw be aware of objects behind the cutting surface.
- Use a good quality paint to spray cut edges of frame to prevent rusting.
- Be sure that **ALL** electrical connections are plugged in and accessories are functioning properly before reinstalling the fascia.
- The baseplate is computer tested to your vehicle's GVWR, exceeding this weight will void the manufacturer's warranty.
- Be sure to use Loctite® Red on all bolts before tightening. Tighten all bolts according to the torque chart provided.
- Dealer or installer be certain the user receives these instruction sheet.
- If the baseplate is in an accident, it must be replaced. **DO NOT** use it again! An accident can cause unseen damage and using it again could result in more damage or serious injury. **DO NOT** use the baseplate if it is damaged or missing parts.

BX3829  
2010-12 VW CC Sport  
2008 VW Passet Turbo  
Installation Instructions

**Tools Required**

Large Vise Grip  
Utility Knife  
Torque Wrench  
Drill  
Reciprocating Saw  
Tape Measure  
Loctite® RED  
13/32" Drill Bit  
16MM Socket  
9/16" Socket  
9/16" Wrench

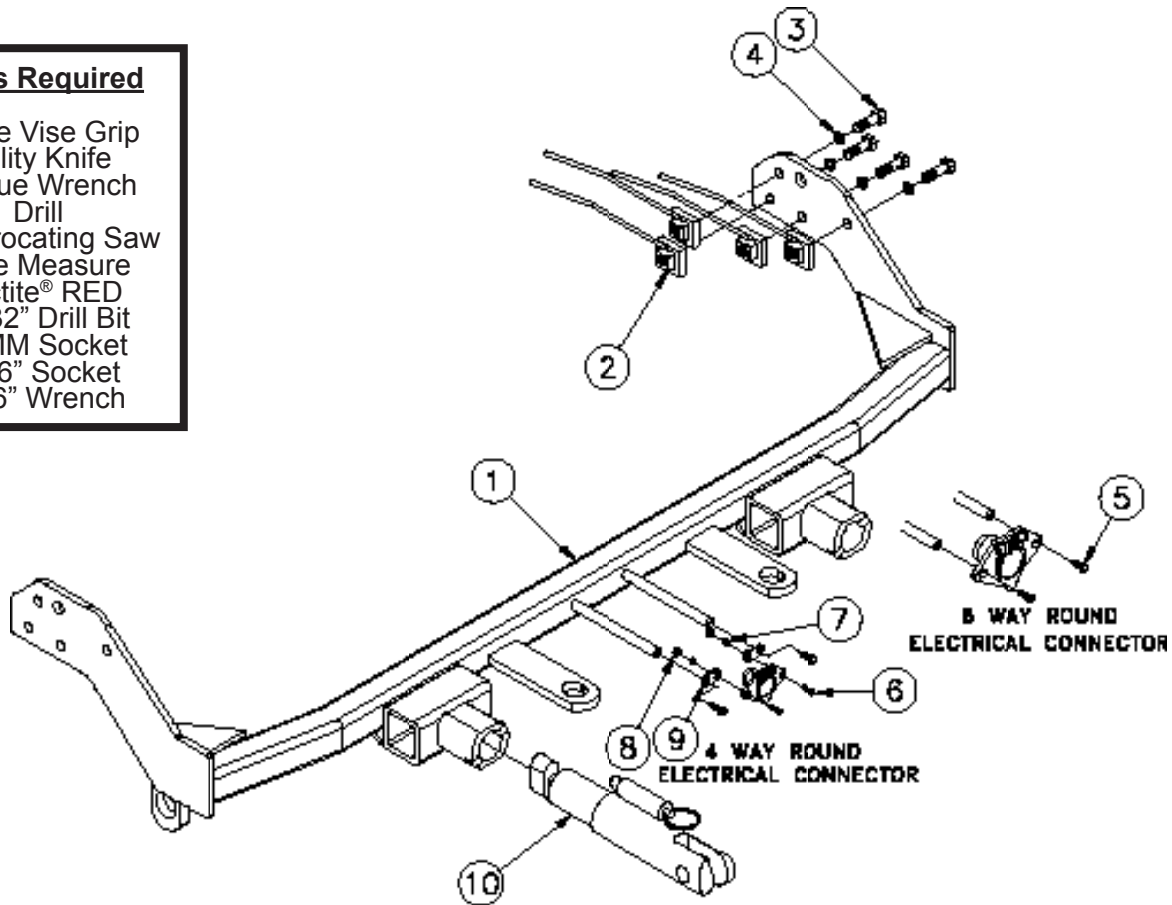

Ref. No.	Qty.	Part #	Description
1	1	61-6755	Weldment, Baseplate, BX3829
2	8	61-5208	Weldment, 3/8-16 Nutplate, w/ 14" Wire
3	8	201-0440	3/8-16 X 1 1/2 Hex Bolt, Grd.5, ZP
4	8	203-0010	3/8 Lock Washer, ZP
5	2	201-0979	#12-14 x 1" Self Drilling Screw, ZP
6	2	201-0192	#10-32 x 1/2" Slot Rd. Hd. Screw
7	2	203-0054	#10 Lock Washer
8	2	202-0047	#10-32 Hex Nut
9	2	101-5822	Adapter, 4 Way Connector
10	2	62-3468	Attachment. Assembly, SF/SB (R)
	1	201-0702	6MM-1.00 X 45MM Hex Bolt, Grd 8.8, (Not Shown)
	1	203-0161	6MM, Lock Washer, ZP (Not Shown)
	7	203-0002	5/16 Flat Washer, ZP (Not Shown)
	1	106-0366	Pipe, 1/4 Sch 40 X 3/4 Inch (Not Shown)
	2	226-0046	Baseplate Safety Cable, 36" CL III (Not Shown)
	2	229-0359	Quicklink, 3/8, ZP (Not Shown)
	2	290-0437	Cap Plug, Black (Not Shown)

**Important:**

Use only genuine factory replacement parts on your baseplate. Do **NOT** substitute homemade or non-typical parts. If a bolt is lost or in need of replacement, for your safety and the preservation of your baseplate, be sure to use a replacement bolt of the same grade (In most cases it will be Grade 5, please reference the parts list above). Replacement parts may be ordered through your nearest Blue Ox® Dealer or Distributor. Failing to follow and/or altering these installation instructions in either installation or required equipment will void the manufacturer's warranty. Towing behind a non-motorized vehicle will void the warranty.



BX3829  
2010-12 VW CC Sport  
2008 VW Passet Turbo  
Installation Instructions



1. **CC:** Using a T25 Torx, remove the four (4) screws from the top edge of the fascia. There are two (2) on each side.

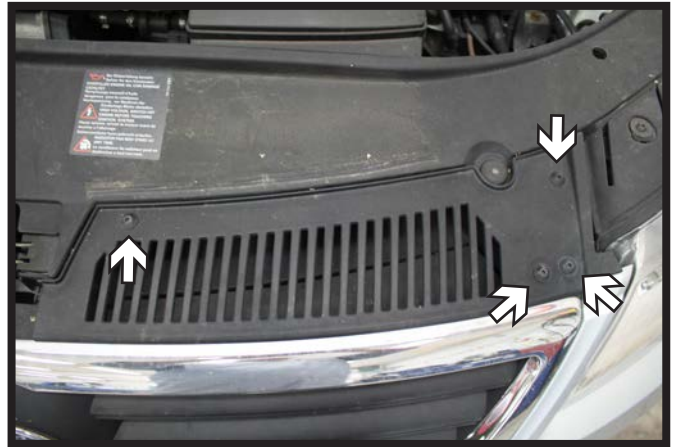

1. **Passet:** Using a T25 Torx, remove the eight (8) screws from the top edge of the fascia. There are two (4) on each side.



2. Using a T25 Torx, remove the two (2) screws from the wheel well. Do this on both sides of the vehicle.



3. Using a T25 Torx, remove the screw from the behind the wheel well. Do this on both sides of the vehicle.



4. Using a T25 Torx, remove the four (4) screws from the underside corners of the fascia. There are two (2) on each side (left). Then remove the one screw in the middle of the fascia (below).

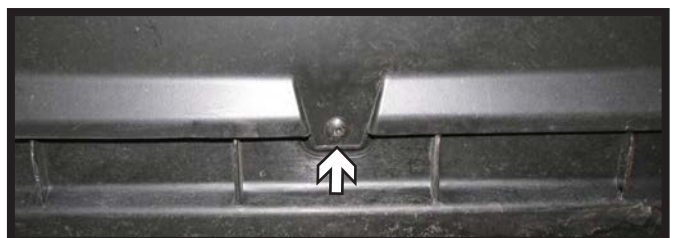

BX3829  
2010-12 VW CC Sport  
2008 VW Passet Turbo  
Installation Instructions

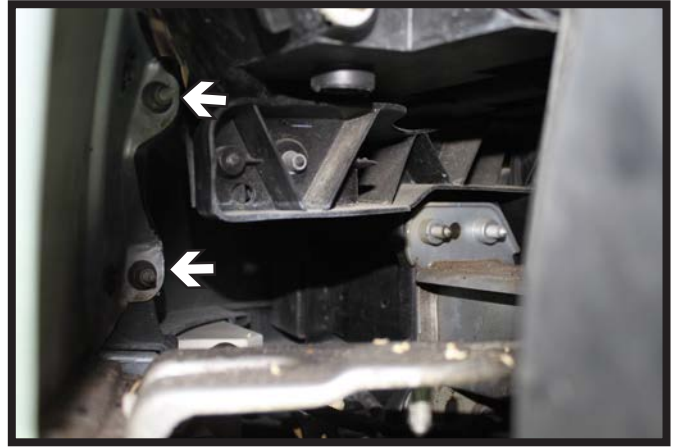

5. **CC:** Using a T25 Torx, remove the two (2) screws from the underside of the fascia. There are one (1) on each side (left).

**Passet:** Using a T25 Torx, remove the four (4) screws from the underside of the fascia. There are two (2) on each side (right).

6. **Passet Only:** Using a 10MM socket, remove the four (4) screws from the backside of the fascia behind the wheel wells. There are two (2) on each side.



7. Pull the corners of the fascia away from the vehicle and disconnect all electrical connections. Remove the fascia and set aside.



8. Pull the center of the grille forward (black) and lift the inner cover up and out (white). Set the grille aside.



BX3829  
2010-12 VW CC Sport  
2008 VW Passat Turbo  
Installation Instructions

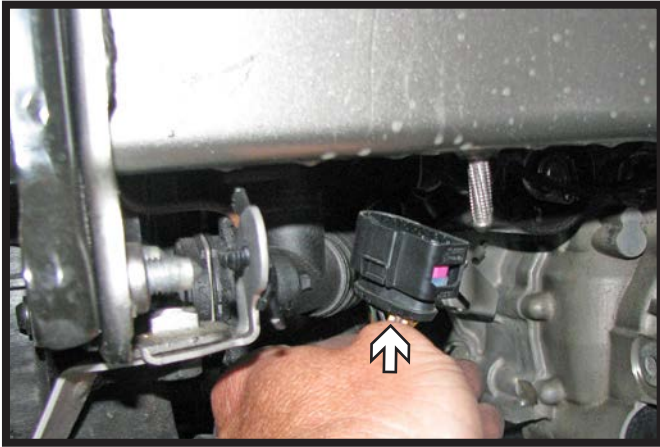

9. On the driver side, disconnect the electrical connection in front of the tire behind the frame.

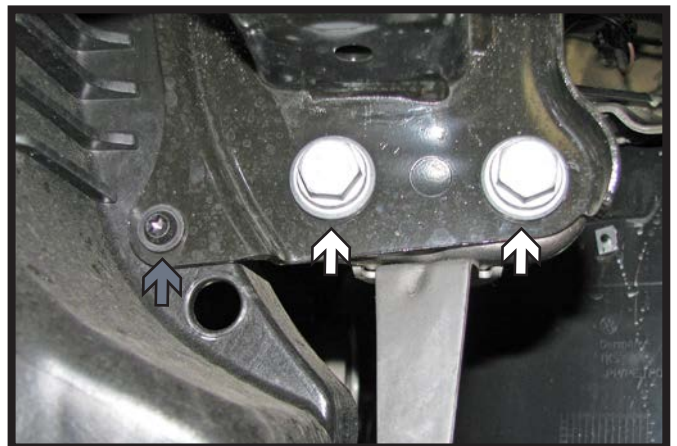
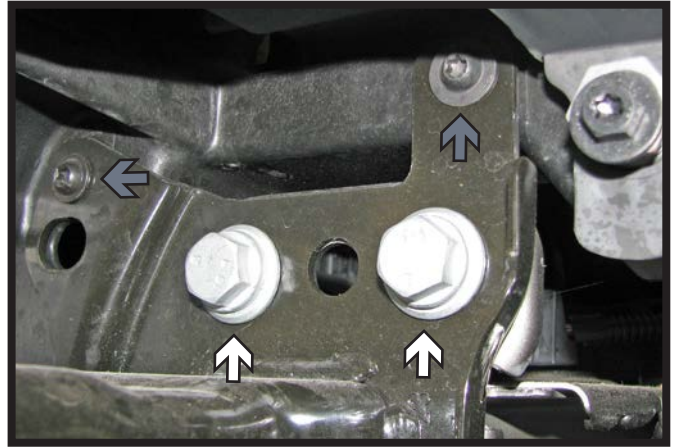

10. Using a 16MM socket, remove the four (4) bolts from the bumper. There are two (2) on top & bottom (white). Using a T30 torx, remove the three (3) screws. There are two (2) on top and one (1) on the bottom (gray). Do this on both sides of the vehicle.



11. Using a T30 Torx, remove the two (2) screws from the center of the bumper. Set the bumper aside.

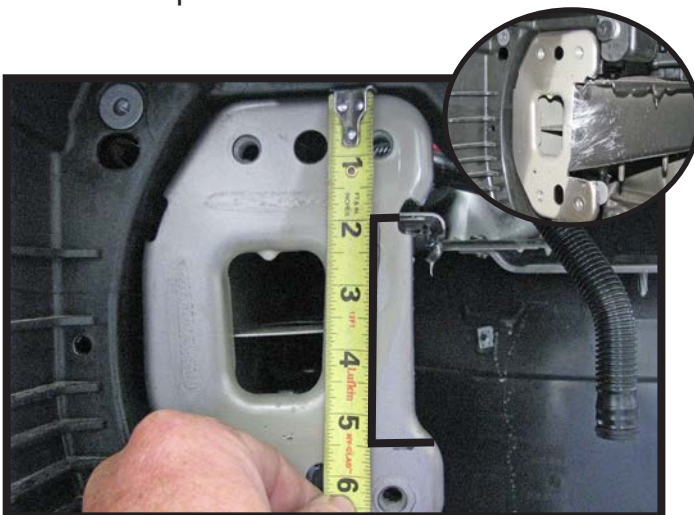

12. Measure from the top edge of the frame end down and mark 2" and 5 1/2" on the side of the frame webbing. Using the reciprocating saw, cut the webbing to the side of the frame rail and make a vertical cut flush with the side of the frame between the first two cuts. Do this on both sides of the vehicle.

BX3829  
2010-12 VW CC Sport  
2008 VW Passat Turbo  
Installation Instructions



13. Place the bumper back to the frame. Mark the backside of the bumper around the area trimmed off the frame on both sides. Using a reciprocating saw, trim off the backside of the bumper. Then reinstall it to the vehicle.



14. Trim the shrouding flush with the bottom of the bumper back the joint then following the joint down to the bottom. Do this on both sides of the vehicle.



15. On the passenger side only, using a reciprocating saw, cut two (2) horizontal slits in the bumper as shown. Bend the tab inwards to allow nut plate access.

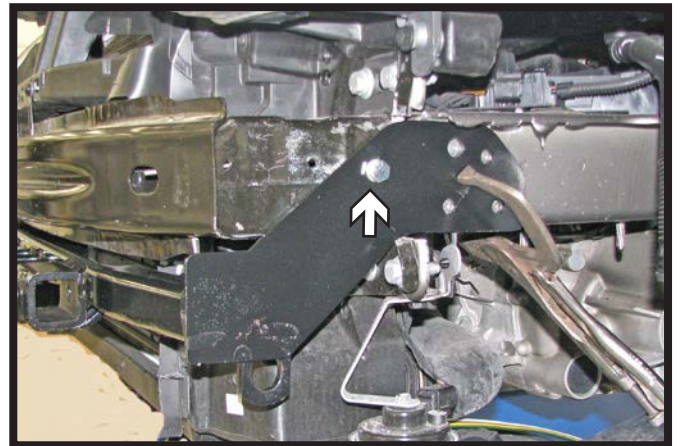

16. Slide the base plate onto the vehicle. Level and clamp the baseplate to the frame. Using the baseplate as a template, drill the first hole in the side of the frame rail with the 13/32" drill bit. Install a 3/8"-13 x 1-1/2" bolt with a 3/8" lock washer into the hole and a 3/8" nut plate into the frame. Do this on both sides. Insure the baseplate is still level and fully tighten fasteners.



BX3829  
2010-12 VW CC Sport  
2008 VW Passet Turbo  
Installation Instructions

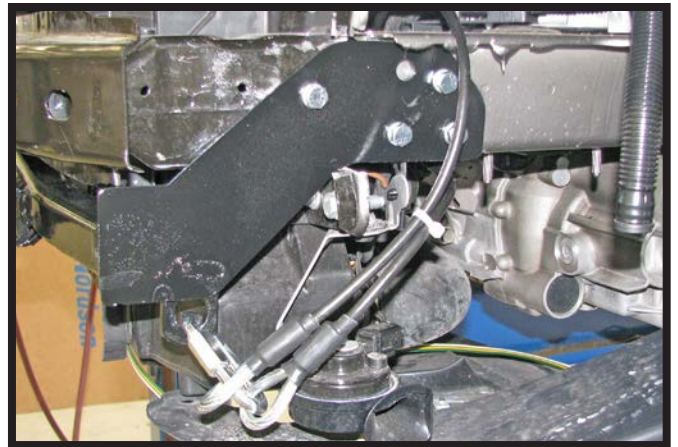
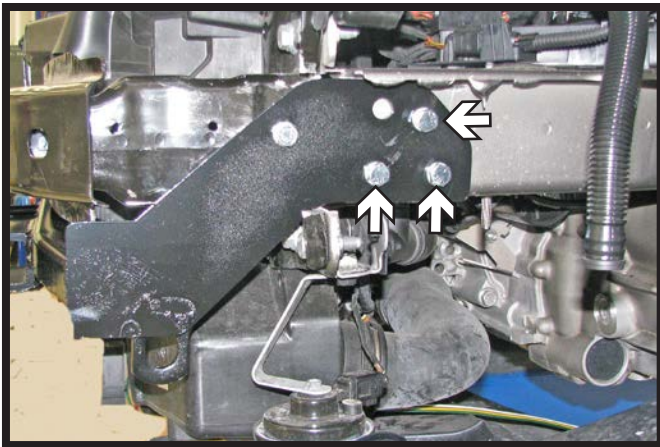

17. Continue drilling out the remaining three (3) holes on each side of the baseplate thru the frame. Install a 3/8"-13 x 1-1/2" bolts with 3/8" lock washers into the holes and a 3/8" nut plates into the frame.

14. Hold the fascia as close to its original position, mark and trim the fascia around the convenience links and attachment tabs. Reinstall the fascia and grille.

18. Attach the permanent baseplate safety cables to the provided convenience link on the baseplate. The photo above shows the recommended installation of the cables to frame of vehicle. Additional options may interfere with suggested mounting; in this case, secure the cables to a solid piece of the frame as described in the instructions included with the permanent baseplate safety cables. Be sure the safety cables do not rub against any hoses or moving parts. Do this on **BOTH** sides of the vehicle.

### CUSTOMER SERVICE COMMITMENT

Blue Ox® is committed to providing you with exceptional customer care throughout your lifetime with our products. Our team is here to assist you with any questions you may have regarding the performance of your product. Simply call (402) 385-3051 and you can speak with our customer care team.

Additionally, please visit our website to see which rallies our Destination America team will be attending. For a nominal fee, our service technician will service your towing system to ensure it's in proper working condition. Also, as a commitment to our customers, should you visit our factory, you can stay at our full service Blue Ox® campground at no charge along with enjoying a factory tour.

Again, thank you for being our customer and for the confidence you have shown in the performance of our products. It is because of customers like you we enjoy the success we have today.

© 2013 Blue Ox  
One Mill Road, Industrial Park  
Pender, Nebraska 68047  
Phone: (402) 385-3051  
Fax: (402) 385-3360  
www.blueox.com



# General Information

1. Ensure that your product(s) are registered online at [www.blueox.com](http://www.blueox.com). It is crucial to register your product(s) so that you may be alerted of product offerings, updates, upgrades, maintenance and safety bulletins, and/or recalls.
2. **It is the owner's responsibility to inspect all towing equipment for cracked welds, missing or worn parts and loose bolts before each towing trip.** Be sure to use Loctite® Red on all bolts and tighten to the recommended specifications.
3. **It is the owner's responsibility to hook up all towing equipment per manufacturer's instructions/recommendations.**
4. Remove the attachment tabs when not in use (if applicable).

## Notice To Baseplate Installer

### 1. It is YOUR responsibility to watch for:

- Oil cooler and air conditioner lines
- Electrical wires and hoses
- Missing parts or attaching points on the frame

\*\* If the baseplate is improperly installed and is against a wire or hose, it could cause fluid leaks or electrical shorts some time after the actual baseplate installation.

## Permanent Baseplate Safety Cable Installation

Permanent baseplate safety cables are strongly recommended when towing a vehicle with a tow bar. The principle function of the permanent baseplate safety cables is to prevent the towed vehicle from breaking loose in the event the connection between the frame of the towed vehicle and the baseplate fails or becomes disconnected. The cables must be connected from the baseplate to the frame rail or cross member of the vehicle's frame. The illustrations below show the possible arrangements recommended by Blue Ox®. Each permanent baseplate safety cable must have an adequate weight rating for the towing system. The weight rating of the two (2) cables together will not qualify.

***Do not mount the permanent baseplate safety cables against wires, hoses or brake lines.***

These permanent baseplate safety cables should remain installed as long as the baseplate is installed on the vehicle. Permanent baseplate safety cables are to be used in conjunction with, and NOT a replacement for legally required safety cables attaching the towed vehicle to the towing vehicle.

### OPTION #1

Permanent Baseplate Safety Cables to Cross Member or Frame of Towed Vehicle.



### OPTION #2

Permanent Baseplate Safety Cables to Cross Member or Frame of Towed Vehicle.

