



# BX2699

## 2024-2025 Lincoln Nautilus Hybrid (Includes Adaptive Cruise Control, Shuttters, & Turbo) Installation Instructions

Please read **BOTH** these Installation Instructions and the General Information sheet prior to installing or operating this equipment.

Serial Number

Attachment Tab Height: 16"

Attachment Tab Width: 25"

Please ensure tow bar being used is compatible with the baseplate tab width.

1. Blue Ox® towing products and accessories are intended to be installed by Blue Ox® Dealers who are familiar with our products and have the equipment and knowledge necessary to do "fit work". If needed, Blue Ox® Dealers can be found at [www.blueox.com](http://www.blueox.com) or by contacting our Customer Care Department at (402) 385-3051.
2. Many Blue Ox® baseplates are designed to use existing holes and hardware to mount the baseplate to the towed vehicle. Even though bolts are there, do not assume they are adequate for baseplate mounting. Always use the hardware supplied in the hardware kit and existing hardware as specified in the installation instructions.

### Bolt Torque Specifications

Torque in Foot-Pounds for Inch Bolts

Bolt Size	Grade 5	Grade 8
1/4"	10	14
5/16"	19	29
3/8"	33	47
7/16"	54	78
1/2"	78	119
5/8"	154	230
3/4"	257	380

### Bolt Torque Specifications

Torque in Foot-Pounds for Metric Bolts

Bolt Size	Grade 8.8	Grade 10.9
6MM	6	8
8MM	16	22
10MM	31	40
12MM	54	70
14MM	89	117
16MM	161	230
18MM	222	318



If the front of your vehicle looks different than this, please contact us at (402)385-3051.

Reference your vehicle owner's manual for manufacturer's towing specifications.



## WARNING

Failure to read and follow these instructions could result in separation of the towed vehicle from the tow bar, causing property damage, loss of towed vehicle, personal injury or death.

BX2699  
2024-2025 Lincoln Nautilus Hybrid  
(Includes Adaptive Cruise Control, Shuttters, & Turbo)  
Installation Instructions

**Instruction Notes:** The fascia, fascia cover, and bottom bumper are removed and reinstalled for the baseplate installation. Some drilling and trimming is required.

Place all components that are removed on a flat, sturdy surface. All items will be reinstalled unless otherwise noted after the baseplate is installed.

The dimensional variations between otherwise identical vehicles can be considerable. While the baseplate was designed for easy installation, it may be necessary to tailor the baseplate slightly to compensate for vehicle manufacturer's tolerances.

The BX8848 Tail Light Wiring Kit is recommended for this vehicle.

## **NOTICE**

- Handling of some cosmetic parts when installing this product may require the use of protective covers, rags, specialty tools, etc. to prevent damage.
- When using power drills be aware of the dangers of torque and drill bit length.
- When using a reciprocating saw be aware of objects behind the cutting surface.
- Use a good quality paint to spray cut edges of frame to prevent rusting.
- Be sure that **ALL** electrical connections are plugged in and accessories are functioning properly before reinstalling the fascia.
- The baseplate is computer tested to your vehicle's GVWR, exceeding this weight will void the manufacturer's warranty.
- Be sure to use a sufficient amount of Loctite® Red on all bolt threads before tightening. Tighten all bolts according to the torque chart provided unless specified.
- Dealer or installer be certain the user receives these instruction sheets.
- If the baseplate is in an accident, it must be replaced. **DO NOT** use it again! An accident can cause unseen damage and using it again could result in more damage or serious injury. **DO NOT** use the baseplate if it is damaged or missing parts.

BX2699  
2024-2025 Lincoln Nautilus Hybrid  
(Includes Adaptive Cruise Control, Shuttters, & Turbo)  
Installation Instructions

**Tools Required**

Flat Screwdriver  
Reciprocating Saw  
Torque Wrench  
Drill  
Loctite® RED  
Level  
Pliers  
3/8" Drill Bit  
1/2" Drill Bit  
7MM Socket  
10MM Socket  
10MM Deep Socket  
11MM Socket  
11MM Wrench  
13MM Socket  
15MM Socket  
3/4" Socket  
3/4" Wrench  
11/16" Wrench

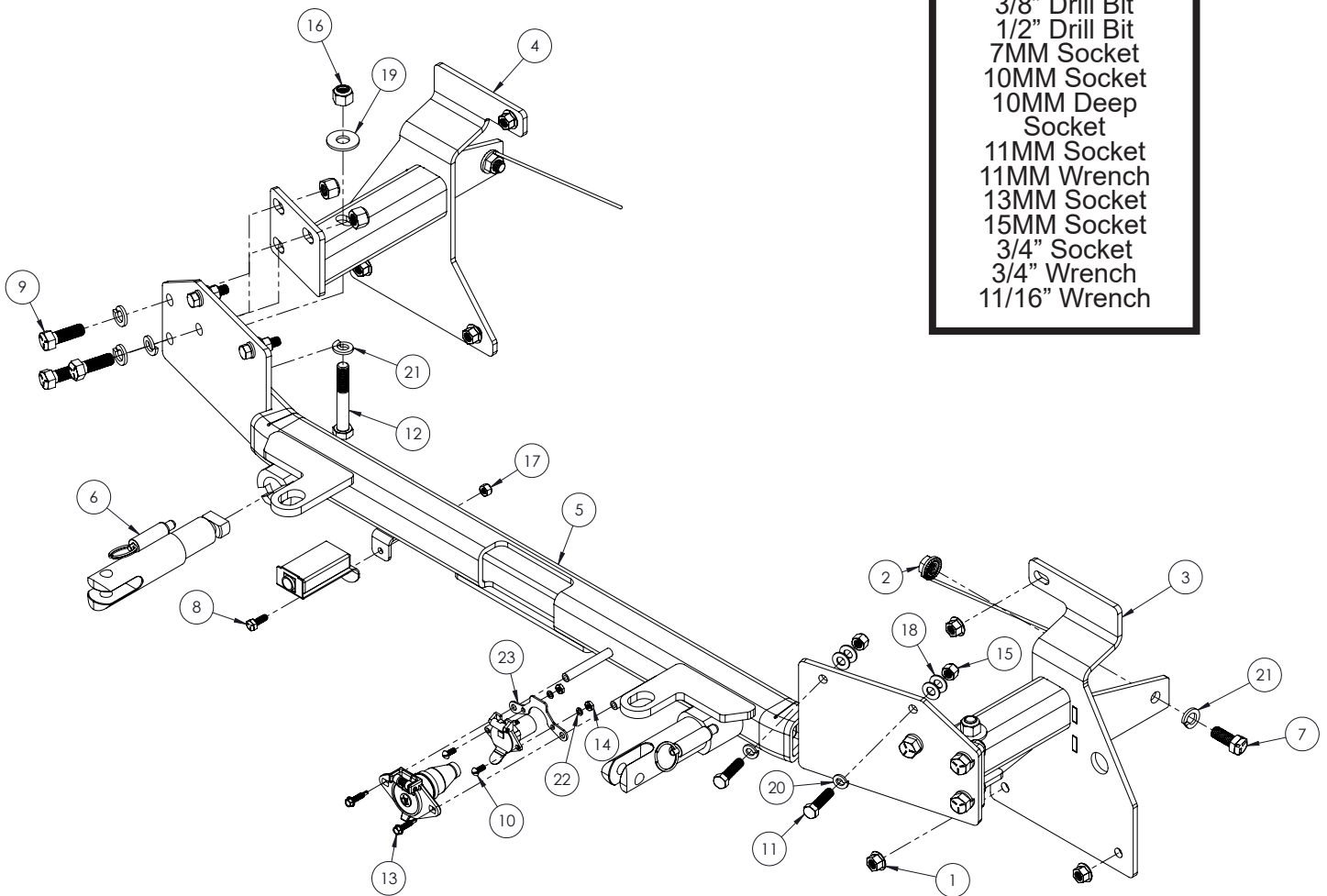

BX2699  
 2024-2025 Lincoln Nautilus Hybrid  
 (Includes Adaptive Cruise Control, Shutters, & Turbo)  
 Installation Instructions

Item No.	Part No.	Description	Qty.
1.....	Existing.....	Flange Hex Nut .....	6
2.....	61-4029.....	1/2"-13" Nut Plate w/ 10" Wire .....	2
3.....	61-8707.....	BX2699 Baseplate, DS.....	1
4.....	61-8708.....	BX2699 Baseplate, PS.....	1
5.....	61-8709.....	BX2699 Baseplate, Center.....	1
6.....	62-3468.....	Attachment Tab Assembly with Hole .....	2
7.....	201-0011.....	1/2"-13 x 1-1/4" Hex Head Bolt, Grade 5, ZP .....	2
8.....	201-0050.....	1/4"-20 x 3/4" Hex Head Bolt, Grade 5, ZP .....	1
9.....	201-0051.....	1/2"-13 x 1-1/2" Hex Head Bolt, Grade 5.....	6
10.....	201-0192.....	#10-32 1/2" Round Slotted Head Screw.....	2
11.....	201-0440.....	3/8"-16 x 1-1/2" Hex Head Bolt, Grade 5, ZP .....	4
12.....	201-0799.....	1/2"-13 x 3-1/4" Hex Head Bolt, Grade 5, ZP .....	2
13.....	201-0979.....	#12-14 x 1" Self Drilling Screw, ZP.....	2
14.....	202-0047.....	#10-32 Hex Nut .....	2
15.....	202-0090.....	3/8"-16 Hex Nylon Insert Lock Nut, ZP.....	4
16.....	202-0094.....	1/2"-13 Hex Nylon Insert Lock Nut, ZP.....	8
17.....	202-0102.....	1/4"-20 Hex Nylon Nut, ZP .....	1
18.....	203-0003.....	3/8" Flat Washer, ZP.....	8
19.....	203-0005.....	1/2" Flat Washer, ZP.....	2
20.....	203-0010.....	3/8" Lock Washer, ZP .....	4
21.....	203-0012.....	1/2" Lock Washer, ZP .....	10
22.....	203-0054.....	#10 Lock Washer, ZP .....	2
23.....	299-0685.....	Electrical Bracket.....	1
24.....	226-0049(not shown).....	Class IV Safety Cables.....	2
25.....	229-0512(not shown).....	1/2" Quicklink, ZP .....	2
26.....	290-0437(not shown).....	Black Cap Plug Receiver.....	2

**Important:**

Use only genuine factory replacement parts on your baseplate. Do **NOT** substitute homemade or non-typical parts. If a bolt is lost or in need of replacement, for your safety and the preservation of your baseplate, be sure to use a replacement bolt of the same grade (In most cases it will be Grade 5, please reference the parts list above). Replacement parts may be ordered through your nearest Blue Ox® Dealer or Distributor. Failing to follow and/or altering these installation instructions in either installation or required equipment will void the manufacturer's warranty. Towing behind a non-motorized vehicle will void the warranty.

BX2699  
2024-2025 Lincoln Nautilus Hybrid  
(Includes Adaptive Cruise Control, Shuttters, & Turbo)  
Installation Instructions

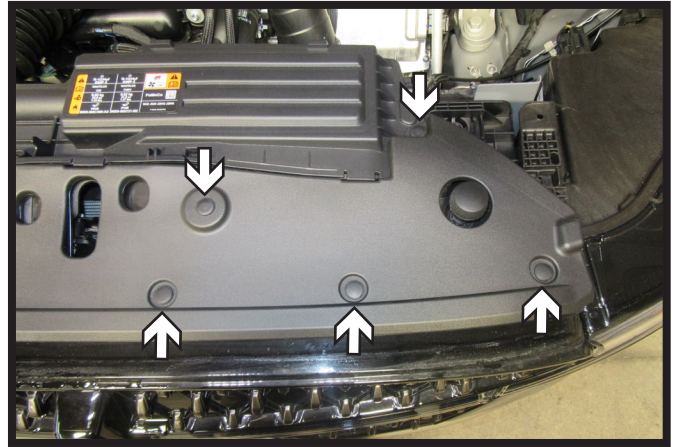
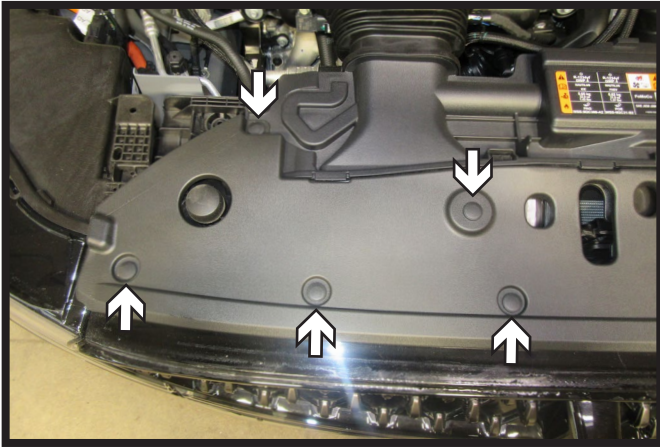

1. Remove the ten (10) push pins from the top of the fascia, there are five (5) on each side of the vehicle. Remove fascia cover and set aside to be reinstalled later.

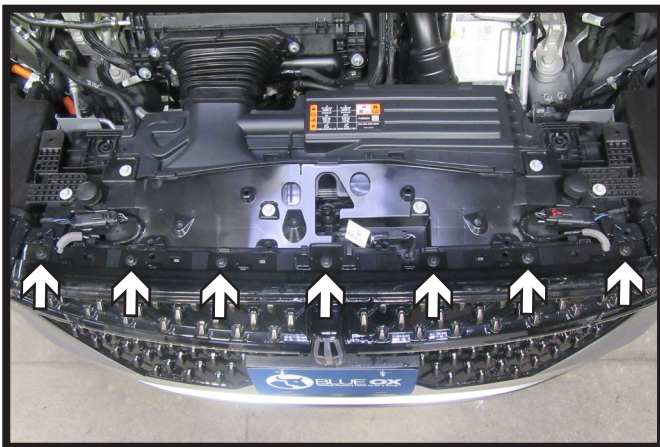

2. Using a 10MM socket, remove the seven (7) bolts from the top of the fascia.



3. Pull back the wheel well trim past the fascia joint releasing the clips. Hold in place with a soft cloth. Do this on both sides of the vehicle.

BX2699  
2024-2025 Lincoln Nautilus Hybrid  
(Includes Adaptive Cruise Control, Shuttters, & Turbo)  
Installation Instructions



4. Remove the four (4) push pins from along the edge of the wheel well. Do this on both sides of the vehicle.

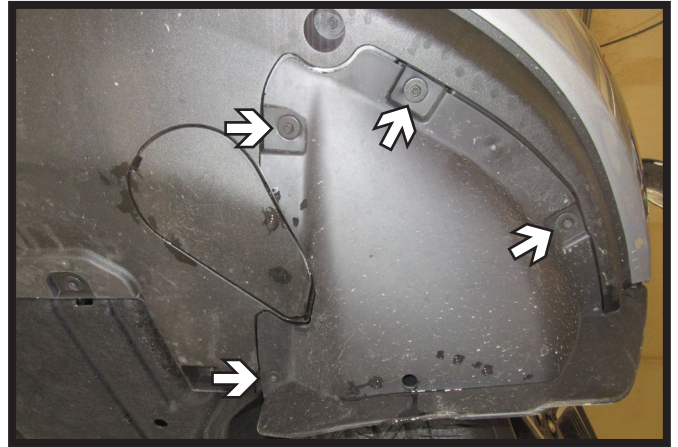

5. Using a 7MM socket, remove the four (4) bolts from the bottom of the fascia in front of the tire. Do this on both sides of the vehicle.

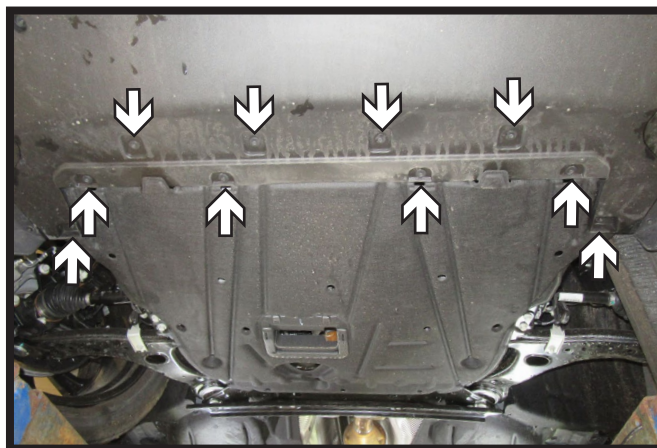

6. Using a 7MM socket, remove the ten (10) bolts from the bottom of the fascia in the center.

BX2699  
2024-2025 Lincoln Nautilus Hybrid  
(Includes Adaptive Cruise Control, Shuttters, & Turbo)  
Installation Instructions

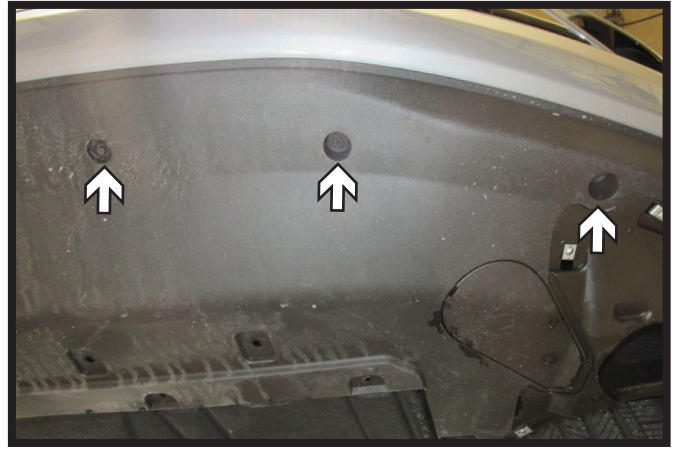
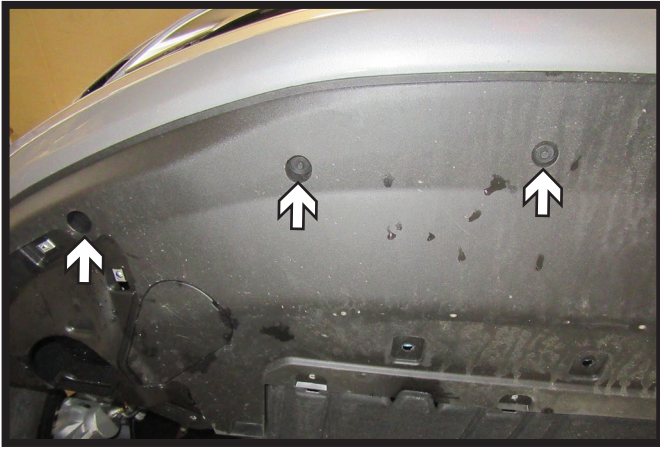

7. Using a 7MM socket, remove the six (6) bolts from along the front edge on the bottom of the fascia.



8. Unplug the three electrical plugs on the top of the fascia.

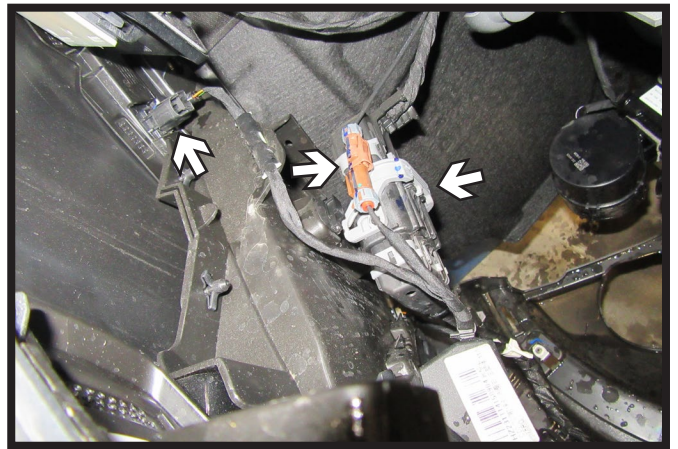

9. Lift up on the tabs on top of the fascia and start to remove. As the fascia is removed, unplug the three (3) electrical connections on the passenger side of the vehicle. Remove fascia and set aside to be reinstalled later.

BX2699  
2024-2025 Lincoln Nautilus Hybrid  
(Includes Adaptive Cruise Control, Shuttters, & Turbo)  
Installation Instructions

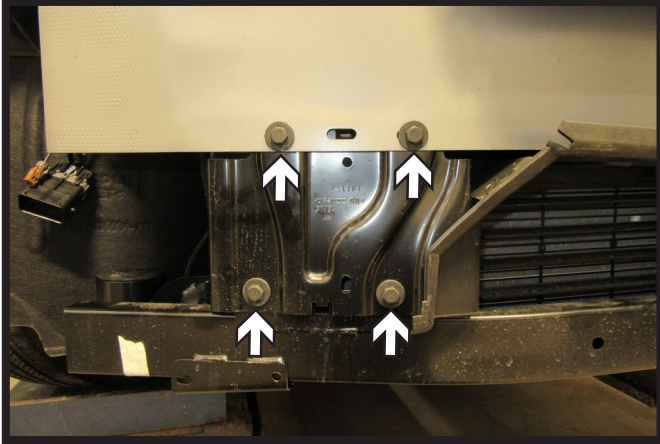

10. Using a 13MM socket, remove the four (4) bolts attaching the support bracket to the bottom and top bumper. Remove bracket, it will not be reinstalled. Do this on both sides of the vehicle.

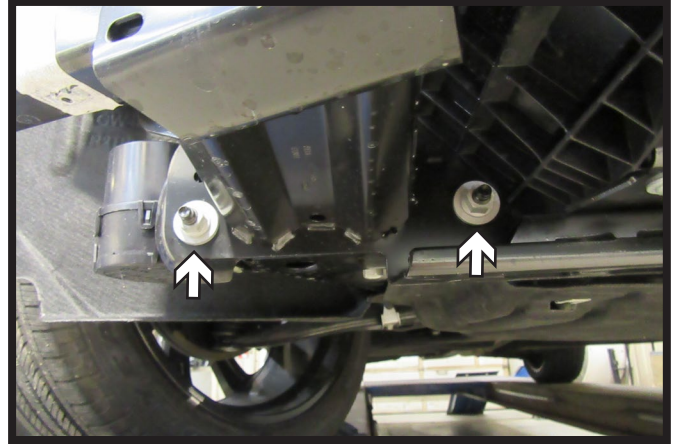

11. Using a 15MM socket, remove the two (2) nuts from behind the bottom bumper. Do this on both sides of the vehicle.

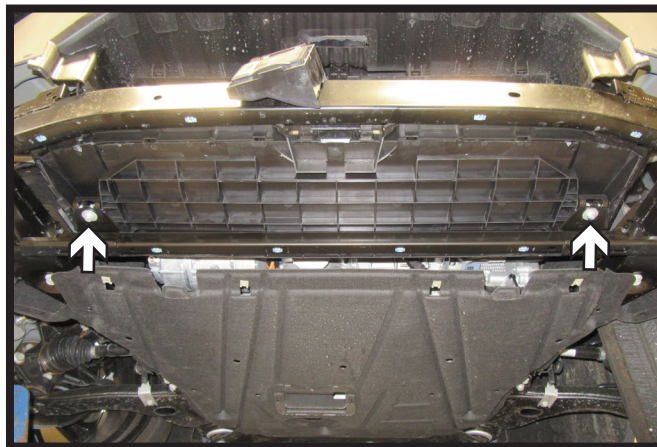

12. Using a 10MM socket, remove the two (2) bolts from the underside of the vehicle. Remove the bottom bumper and set aside to be reinstalled later.



BX2699  
2024-2025 Lincoln Nautilus Hybrid  
(Includes Adaptive Cruise Control, Shutters, & Turbo)  
Installation Instructions

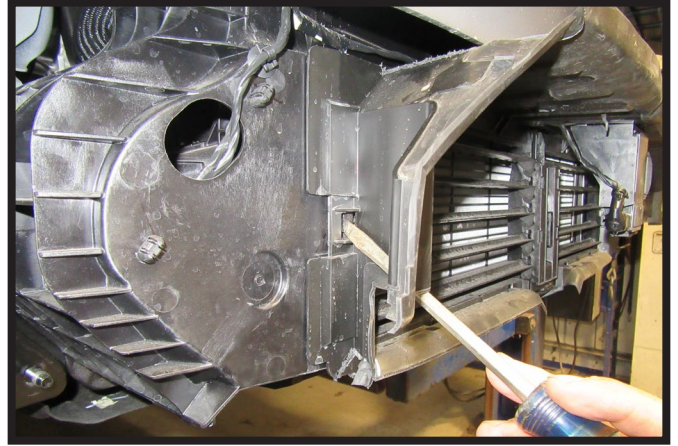
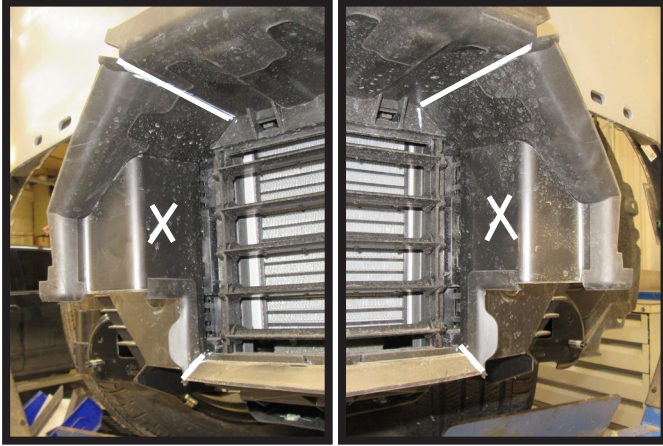

13. Using a reciprocating saw trim the shutter housing as shown. Then using a flat screw driver release the clip on each side of the shutter housing. Remove the trimmed pieces of the housing.

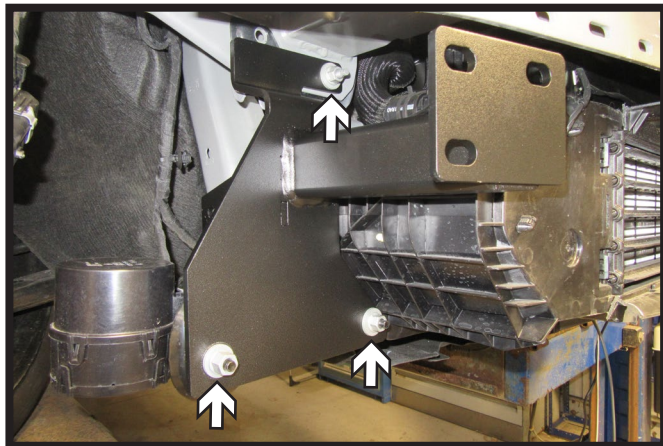

14. Slide the passenger side baseplate piece onto the vehicle and start the three (3) existing nuts. Leave loose at this time.

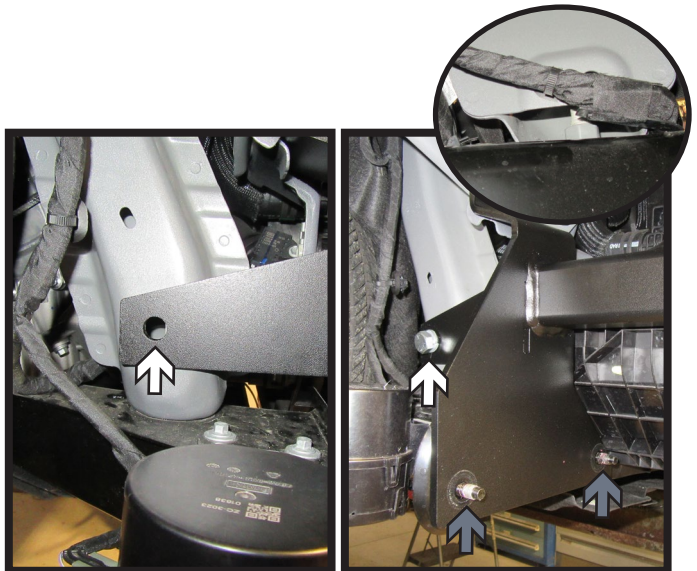

15. Using a 1/2" drill bit, drill out the hole on passenger of the frame using the baseplate as a template. Start the 1/2" bolt (white) with lock washer and whiz nut. Bend wire on whiz nut as needed and install through frame access hole (inset). Leave loose at this time. Remove the nuts from the bottom two bolts (gray).

**\*\* Use Loctite® Red on all bolt threads. \*\***

BX2699  
2024-2025 Lincoln Nautilus Hybrid  
(Includes Adaptive Cruise Control, Shuttters, & Turbo)  
Installation Instructions



16. Using a 10MM socket, remove the one (1) nut from the top of the black box in front of the wheel on the driver side of the vehicle (left). Then remove the wire loom from the backside top bolt. Using a 10MM deep socket, remove the two (2) bolts from the backside (right). Let box hang out of the way for baseplate installation.

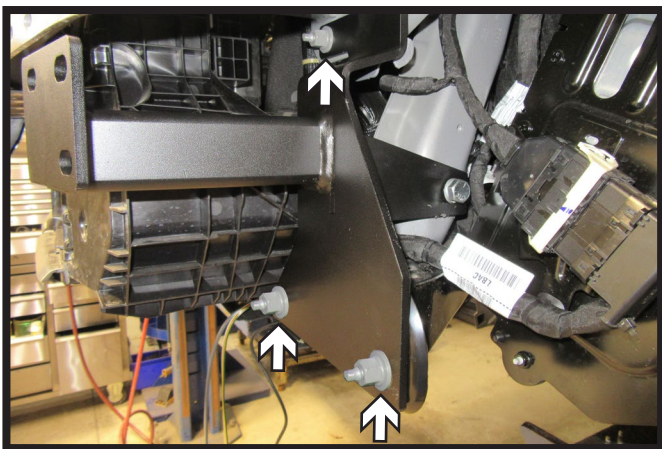

17. Slide the driver side baseplate piece onto the vehicle and start the three nuts. Leave loose at this time.

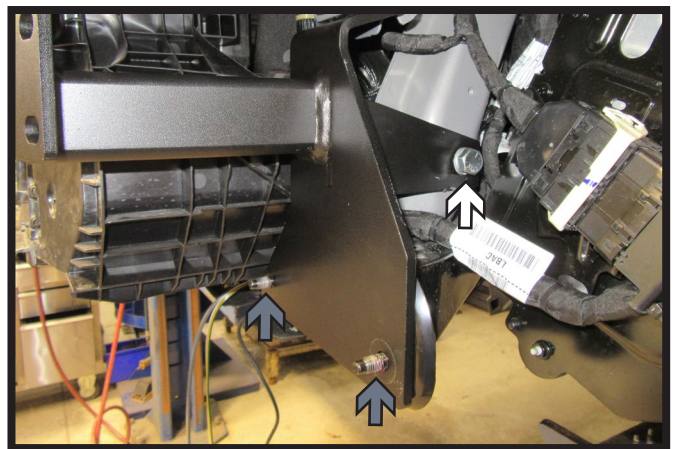

18. Using a 1/2" drill bit, drill hole in driver side of the frame using the baseplate as a template. Start the 1/2" bolt (white) with lock washer and whiz nut. Bend wire on whiz nut as needed and install through frame access hole. Leave loose at this time. Remove the nuts from the bottom two bolts (gray).

**\*\* Use Loctite® Red on all bolt threads. \*\***

BX2699  
2024-2025 Lincoln Nautilus Hybrid  
(Includes Adaptive Cruise Control, Shuttters, & Turbo)  
Installation Instructions

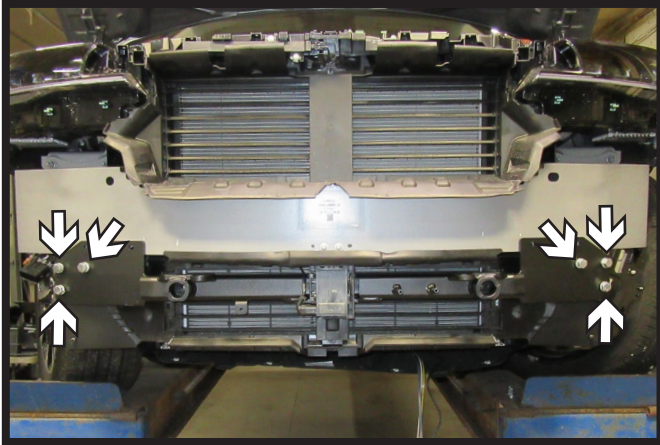

19. Hold baseplate center piece in place and start the three (3) 1/2" bolts with lock washers and nuts on each side of the vehicle, leave loose.

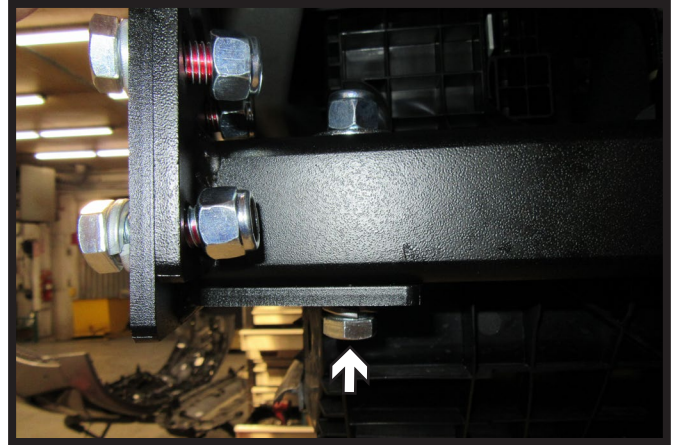

20. Start the one (1) 1/2" bolt in the bottom hole of the center piece with lock washer, flat washer, and nylon lock nut. Leave loose. Do this on both sides of the vehicle.  
**Note:** May need to ream out hole with a 1/2" drill bit.

21. Tighten all the nuts and bolts at this time starting with the top back nut, then the back frame bolt, followed by the front three (3) bolts, and finally the bottom bolt. Do this on both sides of the vehicle.

**\*\* Use Loctite® Red on all bolt threads and tighten all bolts to the appropriate torque. \*\***

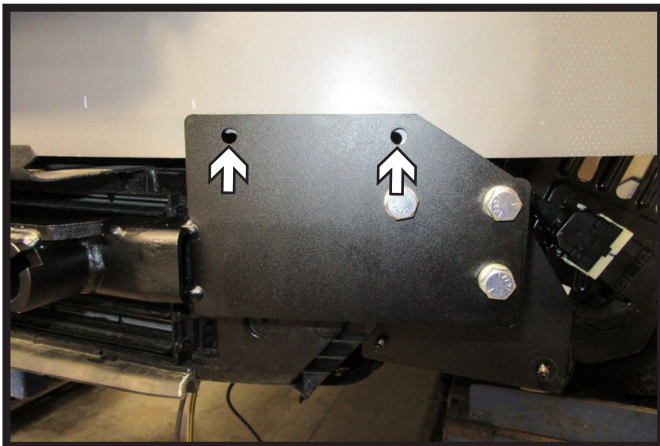

22. Using a 3/8" drill bit, drill out the two (2) holes in the top bumper using the baseplate as a template. Do this on both sides of the vehicle.

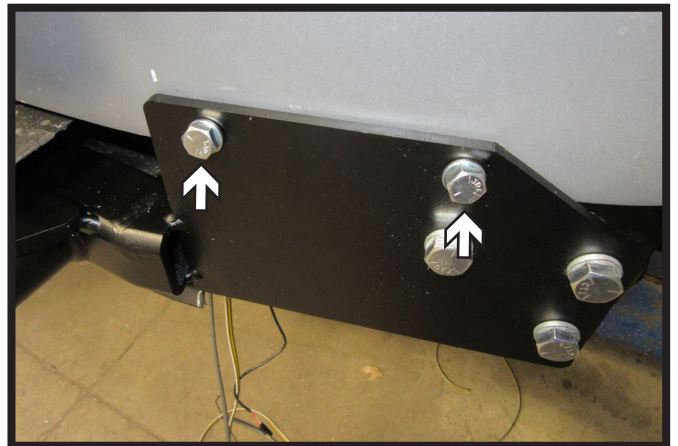

23. Install the two (2) 3/8" bolts with lock washers, flat washers, and nylon lock nuts. Do this on both sides of the vehicle.  
**Note:** Place a flat washer between the baseplate and bumper to remove gap if present.

**\*\* Use Loctite® Red on all bolt threads and tighten all bolts to the appropriate torque. \*\***

BX2699  
2024-2025 Lincoln Nautilus Hybrid  
(Includes Adaptive Cruise Control, Shuttters, & Turbo)  
Installation Instructions



24. Reinstall bottom bumper with existing nuts and bolts.

**\*\* Use Loctite® Red on all bolt threads and tighten all bolts to the appropriate torque. \*\***

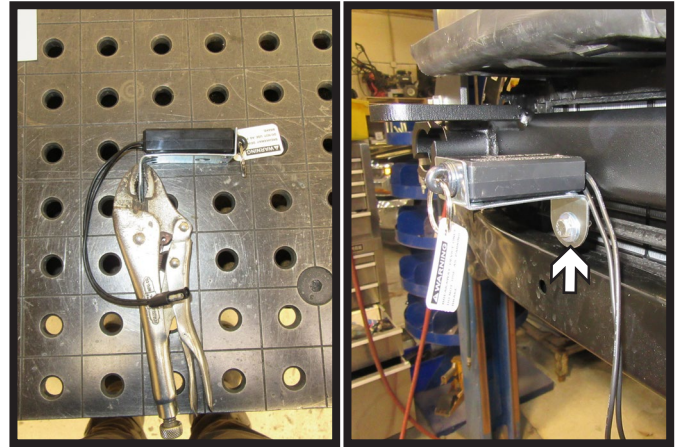

25. **Optional:** Using pliers and a vice grip bend the breakaway bracket as shown. Then using the provided 1/4" bolt with hex nut attach to the bracket on the passenger side of the baseplate.



26. Attach the permanent baseplate safety cables to the provided convenience link on the baseplate. The photo above shows the recommended installation of the cables to frame of vehicle. Additional options may interfere with suggested mounting; in this case, secure the cables to a solid piece of the frame as described in the General Information sheet. Be sure the safety cables do not rub against any hoses or moving parts. Do this on **BOTH** sides of the vehicle.



27. Reinstall the back box on the driver side of the vehicle. Then hold the fascia as close to its original position, mark and trim the fascia around the convenience links and attachment tabs. Reinstall the fascia and fascia cover and reconnect all electrical connections.

BX2699  
2024-2025 Lincoln Nautilus Hybrid  
(Includes Adaptive Cruise Control, Shuttters, & Turbo)  
Installation Instructions

## **CUSTOMER SERVICE COMMITMENT**

Blue Ox® is committed to providing you with exceptional customer care throughout your lifetime with our products. Our team is here to assist you with any questions you may have regarding the performance of your product. Simply call (402) 385-3051 and you can speak with our customer service team.

Additionally, please visit our website to see which rallies our team will be attending. For a nominal fee, our service technician will service your towing system to ensure it's in proper working condition. Also, as a commitment to our customers, should you visit our factory, you can stay at our full service Blue Ox® campground at no charge along with enjoying a factory tour.

Again, thank you for being our customer and for the confidence you have shown in the performance of our products. It is because of customers like you we enjoy the success we have today.



© 2023 Blue Ox  
One Mill Road, Industrial Park  
Pender, Nebraska 68047  
Phone: (402) 385-3051  
Fax: (402) 385-3360  
[www.blueox.com](http://www.blueox.com)

# General Information

1. Ensure that your product(s) are registered online at [www.blueox.com](http://www.blueox.com). It is crucial to register your product(s) so that you may be alerted of product offerings, updates, upgrades, maintenance and safety bulletins, and/or recalls.
2. **It is the owner's responsibility to inspect all towing equipment for cracked welds, missing or worn parts and loose bolts before each towing trip.** Be sure to use Loctite® Red on all bolts and tighten to the recommended specifications.
3. **It is the owner's responsibility to hook up all towing equipment per manufacturer's instructions/recommendations.**
4. Remove the attachment tabs when not in use (if applicable).

## Notice To Baseplate Installer

### 1. It is YOUR responsibility to watch for:

- Oil cooler and air conditioner lines
- Electrical wires and hoses
- Missing parts or attaching points on the frame

\*\* If the baseplate is improperly installed and is against a wire or hose, it could cause fluid leaks or electrical shorts some time after the actual baseplate installation.

## Permanent Baseplate Safety Cable Installation

Permanent baseplate safety cables are strongly recommended when towing a vehicle with a tow bar. The principle function of the permanent baseplate safety cables is to prevent the towed vehicle from breaking loose in the event the connection between the frame of the towed vehicle and the baseplate fails or becomes disconnected. The cables must be connected from the baseplate to the frame rail or cross member of the vehicle's frame. The illustrations below show the possible arrangements recommended by Blue Ox®. Each permanent baseplate safety cable must have an adequate weight rating for the towing system. The weight rating of the two (2) cables together will not qualify.

***Do not mount the permanent baseplate safety cables against wires, hoses or brake lines.***

These permanent baseplate safety cables should remain installed as long as the baseplate is installed on the vehicle. Permanent baseplate safety cables are to be used in conjunction with, and NOT a replacement for legally required safety cables attaching the towed vehicle to the towing vehicle.

### Option #1

(Baseplates with Convenience Link Tabs)

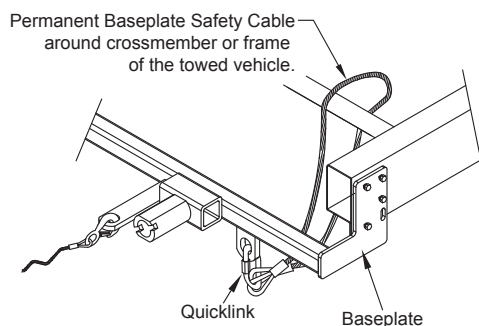

### Option #2

(Baseplates with out Convenience Link Tabs)

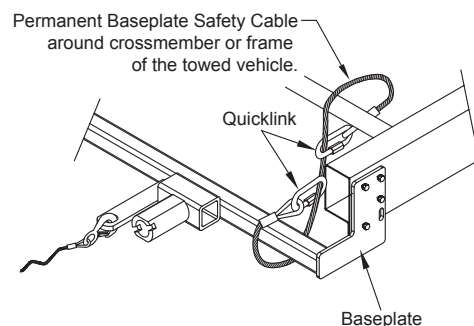

# BLUE OX ORIGINAL PURCHASERS THREE YEAR LIMITED WARRANTY

Automatic Equipment Manufacturing Company ("Automatic") warrants to the original (first) retail purchaser that this product, manufactured by Automatic, shall be free from defect in material and workmanship under normal use and service for a period of three years from the date of delivery.

During said three-year period, Automatic will repair or replace any parts that have been returned by the original purchaser, to the factory, transportation prepaid, and in Automatic's sole and absolute opinion found to be defective.

Limitations on Warranty Coverage:

Coverage under this warranty will be valid only if the customer warranty card is returned by the original purchaser within 30 days of purchase.

Coverage under this warranty will be effective only when a copy of the original invoice, showing date and place of purchase, accompanies any claim for warranty. This warranty is NON TRANSFERABLE.

This limited warranty will not cover, in any way or form, any alleged damages caused by incorrect or improper installation, improper use, modification or neglect of product, failure to properly service and maintain, misuse, act of God, accident or failure of the user to follow guidelines contained in the instructional material provided by Automatic.

This warranty does not cover normal wear and tear, paint or rust.

Warrantor assumes no responsibility to the owner for loss of use of product, loss of time, inconvenience or any other damage consequential or otherwise. Including, but not limited to mileage, expense of transporting of product, return shipping expense, mechanics travel time, telephone, road service, towing, and rental during repairs, travel, lodging, loss or damage to personal property or loss of earnings.

**REPAIR OR REPLACEMENT AS SET FORTH IN THIS LIMITED WARRANTY IS THE SOLE EXCLUSIVE REMEDY OF THE PURCHASER. AUTOMATIC SHALL NOT BE LIABLE FOR ANY INCIDENTAL OR CONSEQUENTIAL DAMAGES FOR BREACH OF ANY EXPRESS OR IMPLIED WARRANTY ON THIS PRODUCT. EXCEPT TO THE EXTENT PROHIBITED BY APPLICABLE LAW, ANY IMPLIED WARRANTY OF MERCHANTABILITY OR FITNESS FOR A PARTICULAR PURPOSE ON THIS PRODUCT IS LIMITED IN LENGTH TO THE DURATION OF THIS WARRANTY.**

Please visit <http://blueox.com/warranty/> to register your warranty



**BLUE OX**